



PROJECT: TYPE:

LOCATION: CAT:



Lamps Sold Separately



Black White Green

Description

Use Commercial Grade Light String for decorative, event oriented, or festive lighting applications.

Features

- 16AWG SPT-2 wire light string available in 330ft bulk reels
- Formulated PVC sockets form a tight seal around bulbs to preclude the entrance of water and moisture
- Non-suspended socket has two mounting ears built into the base
- Use with E12 base Long Life Incandescent Lamps or Pro Decorative Lamps (sold separately)

Mounting

For spans up to 20 feet, use eye bolts and plastic ties to anchor ends. For spans longer than 20 feet, use catenary cable (sold separately) with plastic ties at each socket.

Applications

Patios, overhangs, art installations, tents for weddings or festivals



Technical Information

Series	LS-C-12-BK	LS-C-12-WH	LS-C-12-GR
Length	330ft	330ft	330ft
Socket Type	Solid E12 Base		
Socket Spacing	12"		
Total Sockets	330	330	330
Wire Color	Black	White	Green
Wire Type	16AWG SPT-2 wire; No plug, No terminated end		
Voltage	120V AC, 60Hz		
Max Watts Per Socket	10 watts max per socket		
Max Run	1200 watts		
Cuttability	All cut ends must be sealed properly to preclude the entrance of water		
Rating	Outdoor, year-round use; IP64		
Rated Life	Varies by lamp used		

LS-C Socket Dimensions

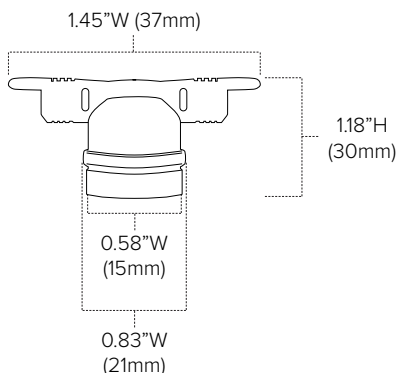

LS-C '330ft Reel' Lead Wire: 12\"/>

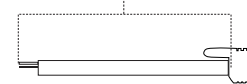

LS-C '330ft Reel' Tail Wire: 4\"/>

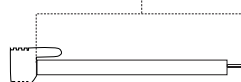

Ordering Information

120V LS-C Series 330ft Bulk Reels

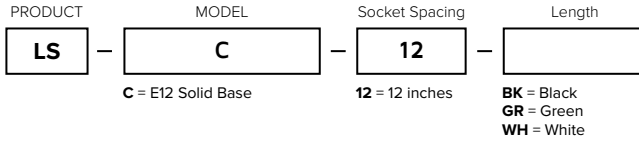









120V LS-C Series 330ft Bulk Reels Include:
(1) 330ft length of LS series commercial grade light string without plug and without terminated end

Example Part # **LS-C-12-BK**



Accessories

Image	Item	Description
	M-PLUG-BK-SPT2-B	Black SPT-2 Male Plugs Slide-on, two prong plugs for SPT-2 2-Wire (Qty of 25)
	M-PLUG-WH-SPT2-B	White SPT-2 Male Plugs Slide-on, two prong plugs for SPT-2 2-Wire (Qty of 25)
	Compatible Lamps	Pro Decorative Series: PG30-E12, PCA10-E12, and PC7-E12 Premium LED Series: NC7-LED2 Long Life Incandescent: B7.5C, C7-5, and C7-7
	LS-CABLE-60	60ft Catenary Cable Kit Includes: (1) 60ft length of 1/8" diameter catenary/guide cable for light string installation, (2) Heavy duty cable locks, and (1) Cable release key
	LS-CABLE-110	110ft Catenary Cable Kit Includes: (1) 110ft length of 1/8" diameter catenary/guide cable for light string installation, (2) Heavy duty cable locks, and (1) Cable release key
	LS-CABLE-500	500ft Catenary Cable Bulk Reel Includes: (1) 550ft length of 1/8" diameter catenary/guide cable for light string installation
	LS-LOCK-4	(4) Heavy duty cable locks for 1/8" catenary cable; Support loads up to 330lbs; Includes cable release key
	LS-TT	Tensioning Tool; use to eliminate sag from catenary cable. Never tighten cable before load is attached; Never over-tighten cable

Additional Information

SUSPENDING LIGHT STRINGS:

Light sockets must be suspended so that bulbs are facing down only. **DO NOT MOUNT THE LIGHT STRINGS WITH SOCKETS FACING UPWARD!**

1. Light string must be securely attached to a support structure at each end of each span. The maximum unsupported span distance for 48' Cord & Plug Light String is 20 feet (10 sockets).
2. Secure light string to supporting hardware (eyebolts, brackets, etc., not provided) using cable ties (not included). See Figure 1.
3. Ensure any cut ends are properly sealed to preclude the entrance of water.
4. For spans exceeding 20 feet, use properly rated cable support system and cable ties (neither are provided with the light string) and follow local codes for suspended cables and loads. See www.americanlighting.com for steel cable support systems, if needed.

