

INSTALLATION INSTRUCTIONS WW-L48-RGB

⚠ WARNING

These products may represent a possible shock or fire hazard if improperly installed or attached in any way. Products should be installed in accordance with these instructions, current electrical codes, and/or the current National Electric Code (NEC).

⚠ WARNING

This unit requires a 120V AC input power. Disconnect supply power at the source prior to installation.

⚠ WARNING

When using this product outdoors, basic safety precautions should always be followed to reduce the risk of fire, electric shock and personal injury including the following:

- Ground Fault Circuit Interrupter (GFCI) protection should be provided on the circuit(s) or outlet(s) to be used for outdoor use. Receptacles are available having built-in GFCI protection for this measure of safety.
- Use only outdoor extension cords, such as type SEW, SEOW, SEOOW, SOW, SOOW, STW, STOW, STOOW, SJEW, SJEOW, SJEOWW, SJTW, SJTOW, or SJTOOW. This designation is marked in the wire of the extension cord. Never use with an extension cord unless plug can be fully inserted.

SAFETY INFORMATION

- Read all instructions before beginning. Save these instructions for future use.
- To reduce the risk of fire, electric shock, or injury to persons, pay close attention to this manual. Stay within its guidelines when using this product.
- All units must be unplugged before installing or servicing in any way.
- Do not route cords or units through walls, doors, windows, or any similar part of a building structure.
- Do not use if there is any damage to the unit, its lens, and/or power cord's insulation. Inspect periodically.
- The fixture is rated for wet locations (IP65) and can be exposed to rain and snow. However, do not let the unit stand in water or liquid, nor locate where water can accumulate.
- Secure units with mounting hardware appropriate for the mounting surface. Do not secure unit or its power cord with staples, nails, or like materials that may damage insulation.
- Do not attempt to open or service this fixture. None of its parts are serviceable by the user.
- Do not exceed the specified voltage and current input: 120V AC, 0.54A per unit.
- If using in conjunction with the WW-CON-RGB controller, do not exceed the maximum run of thirty units.
- This product has a grounded plug as a safety feature to reduce the risk of electric shock. Do not cut the plug off or alter it in any way.
- Provide a grounded receptacle for within 5 feet of each fixture's location. If using outdoors, outlet(s) must also be GFCI and weatherproof.
- The maximum number of fixtures that can be controlled by the WW-CON-RGB controller is thirty (30). For any project that requires more than thirty (30) fixtures, please consult factory.

BEFORE INSTALLATION:

1. Get familiar with the key parts of the WW-L48-RGB. See FIGURE 1.
2. Determine number of fixtures to be used and how power will be delivered.
3. Determine mounting method and fasteners required. See FIGURES 4 and 5 on page 4 for details.
4. Determine if signal cable extensions are needed. Fifteen foot signal cable extensions (item number WW-EC15, sold separately) can be used when distances between two fixtures exceed 24". Signal cable extensions can be interconnected to create longer lengths when needed. Built-in signal cables are IP65 rated for use in damp location use, but cables may not be located where water can stand or accumulate.
5. Determine method of color control.
 - Multiple fixtures can be controlled individually (must have access to all units) or synchronously (must have access to the first unit only) using built-in standalone features. To synchronize, all fixtures must be interconnected with their input and output data cables. The first unit will control all interconnected fixtures. The maximum number that can be interconnected with signal cables is thirty fixtures. See page 2 for details.
 - An external controller (DMX-RGB-3, sold separately) can control all interconnected fixtures (up to thirty maximum) to have mixing levels at your fingertips and/or to use sound activation. See page 3 for details.
 - A DMX hardware/software set up with a XLR3-CUSTOM adapter cable (made to order, sold separately) is needed. See page 4 for details.

FIGURE 1

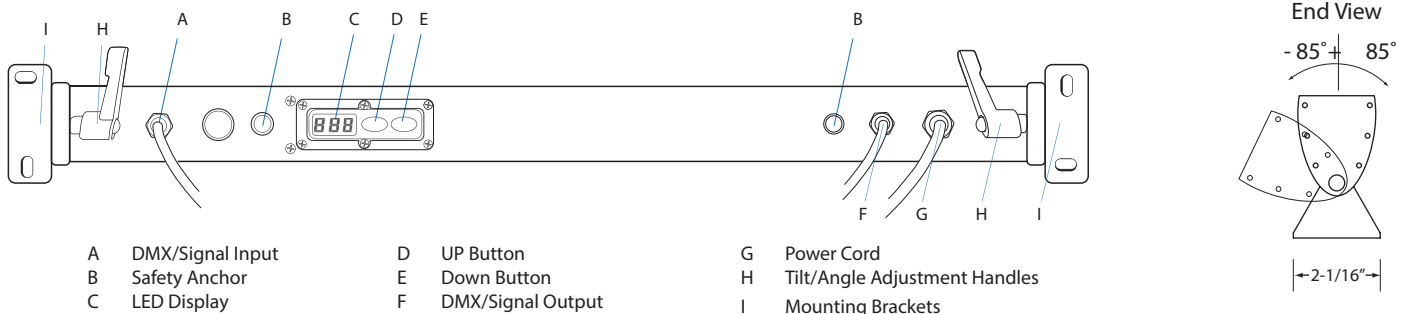

INSTALLATION INSTRUCTIONS

WW-L48-RGB

If the fixture(s) will be hard to reach after install, skip to “Standalone Color Control” (below) before mounting/installing. If using DMX512 color control, label and set fixtures’ IDs (see page 4) before mounting/installing fixtures.

FIXTURE INSTALLATION:

1. Loosen the tilt/angle adjustment handles, to rotate the light to get access to the mounting brackets.
2. Use the through-mounting holes in the brackets of each unit (See FIGURE 2) and suitable fasteners. Make a fixture layout plan that shows the locations of each fixture and controller.
3. Interconnect multiple fixtures with their signal cables, with or without additional signal extension cables (WW-EC15, sold separately), as applicable.
4. If using an external controller, connect the controller’s DMX cable to the signal input of the first wall washer.

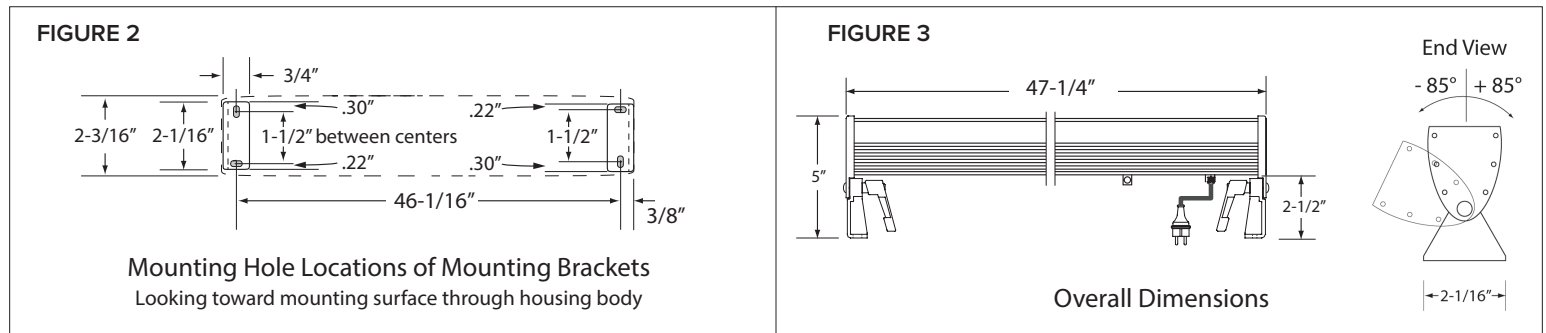

STANDALONE COLOR CONTROL - WHEN AND HOW TO USE IT:

Multiple fixtures controlled individually, or interconnected and controlled synchronously - mix Red, Green and Blue values and set flash or fade modes with the built-in programs (see step 5 and the following example below for details). To synchronize up to 30 fixtures, interconnect their signal cables and set all but the first fixture to “001”, then set the first fixture according to the following.

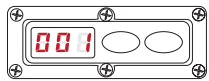

1. With the LED Display showing “001”, press both UP and DOWN buttons simultaneously to enter Standalone Mode. Follow steps 2 - 4 if you want to select your own mix of R, G and B light levels. Otherwise, you can skip to step 5 to use built-in programs.

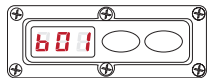

2. Blue Light Setting - a stylized “b” and the value “01” will appear on the LED Display. Press the UP Button to advance up to “10”. “01” is the lowest Blue light output and “10” is the highest.

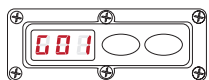

3. Green Light Setting - a stylized “G” and the value “01” will appear on the LED Display. Press the UP Button to advance up to “10”. “01” is the lowest Green light output and “10” is the highest.

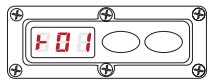

4. Red Light Setting - a stylized “r” and the value “01” will appear on the LED Display. Press the UP Button to advance up to “10”. “01” is the lowest Red light output and “10” is the highest.



Mode Parameter



PG / Program Mode: PG1 = R > G > B, PG2 = R > RG > G > GB > BR, and PG3 = R > RG > G (all cycle/repeat).



SP / Speed Mode: SP1 is the fastest and SP4 is the slowest

St / Strobe Mode: SP0 is no strobe effect, St1 is the fastest and St4 is the slowest

Fd / Fade Mode: Fd0 is no strobe effect, Fd1 is the fastest and Fd4 is the slowest

HELPFUL HINT:

For the slowest color fade effect, set Program Mode to PG2, Fade Mode to Fd4, Strobe Mode to SP0 and Speed Mode to SP4.

INSTALLATION INSTRUCTIONS WW-L48-RGB

USING DMX-RGB-3 FOR COLOR CONTROL:

If the fixture(s) will be hard to reach after install, and/or you want mixing level sliders; and/or you want to change instantly to preset colors; and/or you want to use sound activation, then the DMX-RGB-3 should be used as your color controller. Note: DMX-RGB-3 must be located in a dry location. It includes a 12V DC wall adapter and 7ft power cord which requires a 120V outlet.

Determine which DMX adaptor cable will be needed (WW-RGB-XLR3 or WW-RGB-XLR3-15 or XLR3-CUSTOM, each sold separately) to connect the color control unit to the first wall washer. Connect the XLR3 cable to the “DMX OUT” port on the back of the unit. See Figure 5.

FIGURE 4

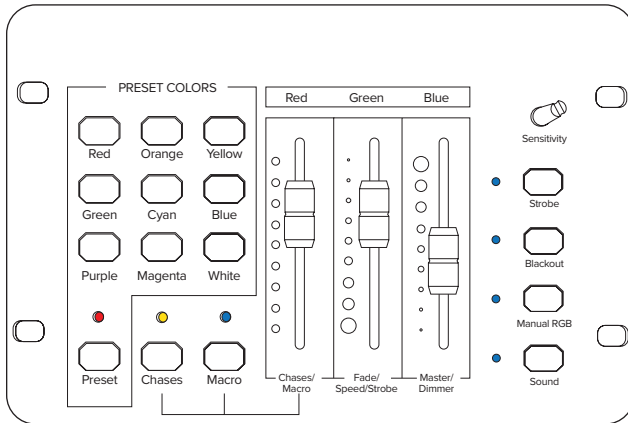

Front View

FIGURE 5

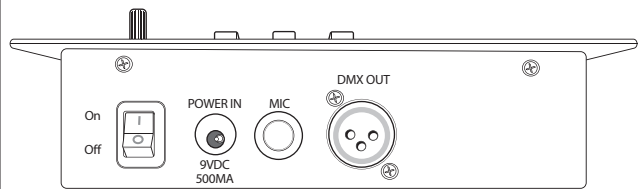

Back View

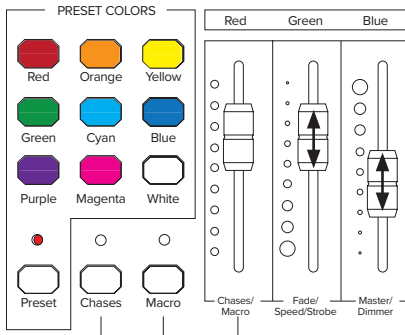

PRESET COLORS

- There are nine colors on the DMX-RGB-3 unit preset for quick color changes at the press of a button.
 - Press the “Preset” button at the bottom to activate the function
 - Press any of the nine color buttons
 - Slide the “Fade/Speed/Strobe” slider up or down to adjust the fade rate from one preset color to the next (from 0.1 - 60 seconds)
 - Slide the “Master/Dimmer” slider up or down to control the brightness

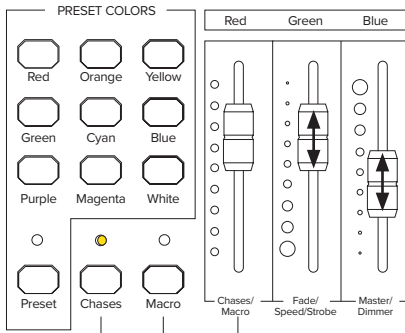

CHASE MODE

- There are nine chasing effects you can access using the “Chases” function.
 - Press the “Chases” button to activate the function
 - Slide the “Chases/Macro” slider to move through the chase effects (see below)
 - Slide the “Fade/Speed/Strobe” slider up or down to adjust the fade rate from one preset color to the next (from 0.1 - 60 seconds)
 - Slide the “Master/Dimmer” slider up or down to control the brightness

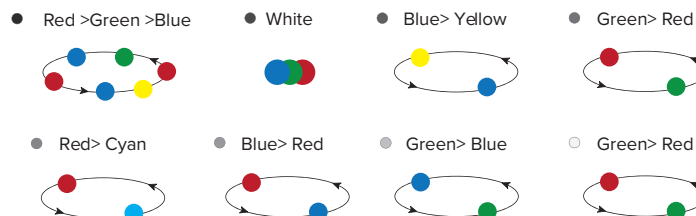

INSTALLATION INSTRUCTIONS WW-L48-RGB

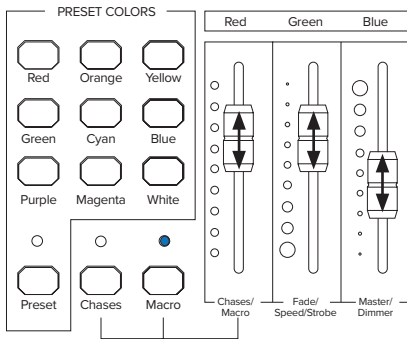

MACRO MODE

- Use the “Macro” function to produce slow and smooth fade effects
 - Press the “Macro” button to activate the function
 - Slide the “Chases/Macro” slider to move through the fade effects (see below)
 - Slide the “Fade/Speed/Strobe” slider up or down to adjust the fade rate (from 0.1 - 60 seconds)
 - Slide the “Master/Dimmer” slider up or down to control the brightness

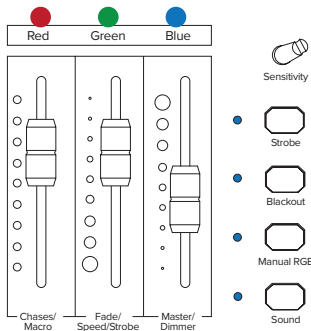

ADVANCED EFFECTS

- The four buttons work as follows:
 - Strobe: produces regular flashes of light
 - Blackout: produces darkness / no light output
 - Manual RGB: allows Red, Green and Blue light output to be adjusted manually using the individual sliders
 - Sound: converts the color control to a sound activated mode - use the sensitivity knob to adjust the level of sound sensitivity

USING DMX512 FOR COLOR CONTROL:

- Make a fixture layout plan that shows the locations of each fixture and controller. Leave room to create a legend to record the fixture “IDs” (fixture address number).
- As you unpack each fixture, attach a weatherproof label on the fixture with its ID.
- Record each fixture’s ID on the lighting plan.
- Set the fixtures’ IDs using the UP and DOWN buttons on the underside of the fixture housing. See FIGURE 1. The ID will show on the LED Display and be held in memory even when unplugged or otherwise powered off.
 - If you want all of the fixture to be synchronized, give them all the same ID.
 - If you want them to do different things at the same time, give them different IDs, ie. 001, 004, 007, 010, etc, skipping two digits for each following ID is customary for basic fixtures that use three channels. FYI, more complex fixtures that have pan, tilt or other features will need a larger range.
- Check the distance between the DMX equipment (by others) and the first fixture. You will need to get a DMX signal adapter cable to connect these two items, WW-XLR3 (2ft adapter cable) or WW-XLR3-15 (15ft adapter cable). Note that you can extend those previously mentioned adapter cables with interconnecting WW-EC15 (15ft signal cable), using multiples to make the length as needed.
- Use WW-EC15 signal cables as needed between fixtures.