

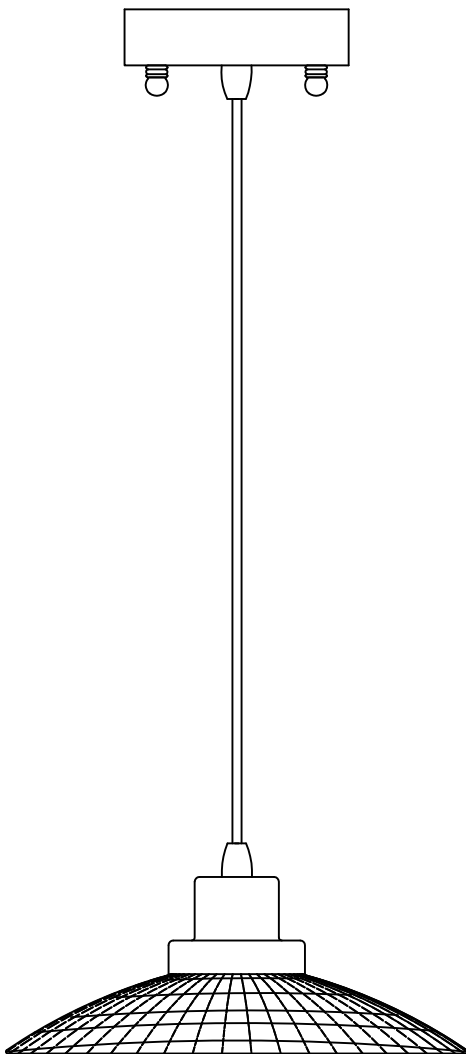

PRODUCT NAME: Retro
ITEM NUMBER: 25197CLPN

Please consult your electrician for hanging fixture and wiring.



The fixture is designed to dim with a standard Triac forward phase dimmer. Dimming levels will vary by dimmer.

Below is a list of recommended dimmers:

- Lutron MACL-153M
- Lutron DVL-153P
- Lutron SCL-153P
- Leviton IPL06-10Z
- Leviton 6674-POW

Due to inrush current, wattage should not exceed 150 Watts of product for a 600W dimmer.

8W LED

IMPORTANT: Turn off the power at the main fuse or circuit breaker box before starting installation



A
Mounting Bracket

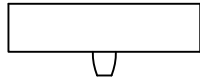

B
Canopy



C
Finial

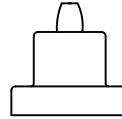

D
Cup

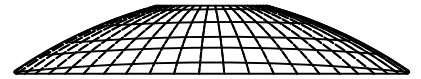

E
Glass

Locate all hardware & components before discarding packaging

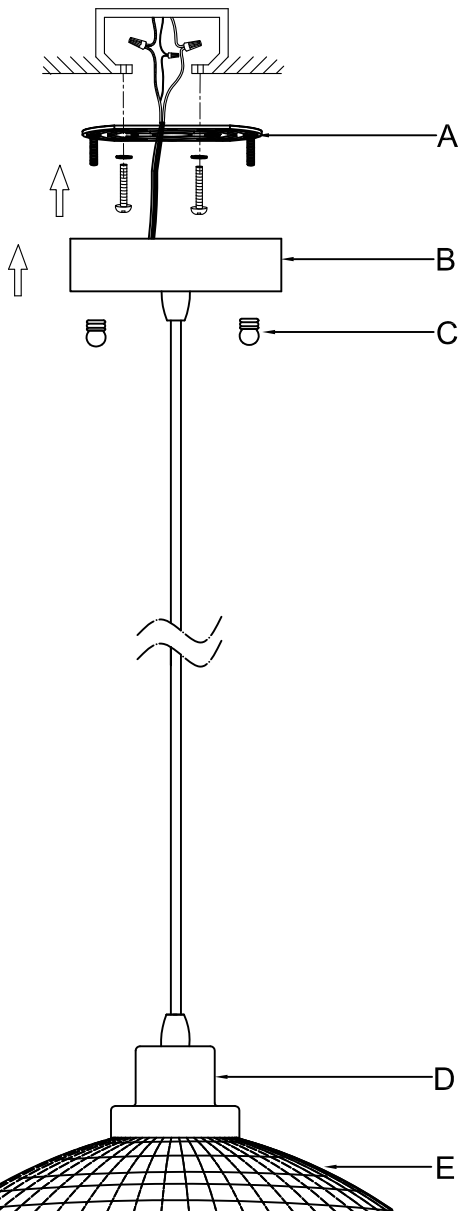

1.)

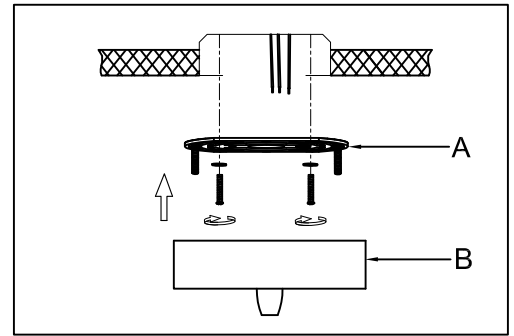

Step 1: Remove mounting bracket (A) from canopy (B) and install to electrical box.

2.)

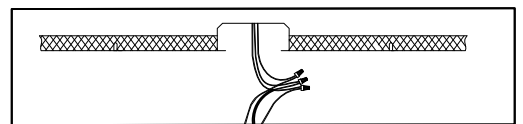

Step 2: Wire fixtures to wires in outlet box. Green wire is ground.

3.)

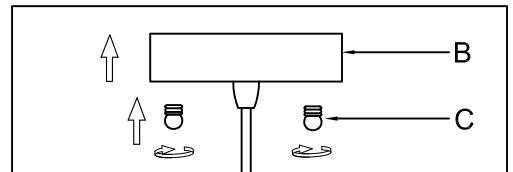

Step 3: Adjust wire length to desired mounting height and tighten strain relief screws to secure. Install canopy (B) to bracket using finials (C) to secure.

Cleaning & Care:

Clean with soft cloth and a mild detergent.
Do not use abrasive cleaner.