

OPERATING INSTRUCTIONS

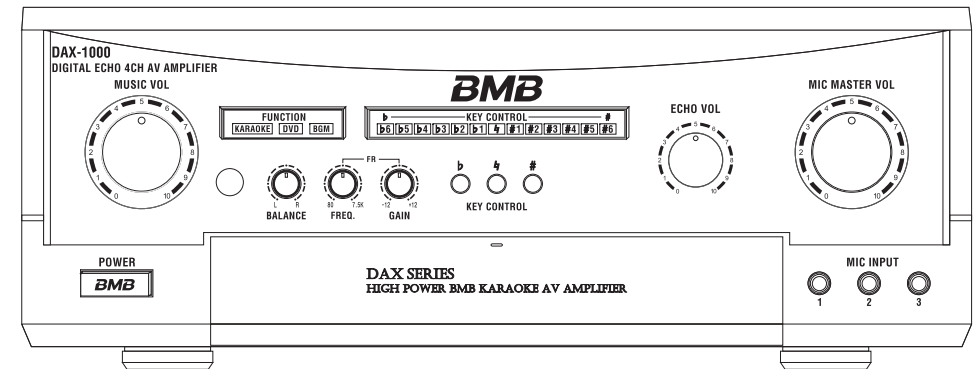

BMB Corp.
<http://www.bmb.co.jp>

Thank you for purchasing our product.
In order to enable you to use the product correctly,
please read the operating instructions carefully before using the product.

TABLE OF CONTENTS

Safety marks	2	Setup of motor volume output adjustment	13
Characteristics	3	Basic operation	14
Precautions for installation	4	Detailed operating method	15
Safety precautions	5	Operating method of remote controller	16
Name and function description on the front panel	6	Troubleshooting	17
Name and function description on the rear panel	8	Others	18
Connection diagram of external equipments	11	Specifications	19
Precautions for connection	12		

SAFETY MARKS

In order to enable the user to use the product correctly and conveniently and prevent any body injury and property loss in using, please read the following precautions carefully before using the product.

The safety marks are defined as follow:



WARNING

It might cause serious body injury and even death accident if it's used in breach of the instructions.



ATTENTION

It might cause serious body injury or product damage if it's used in breach of the mark instructions.



The sign at the left means the content of the noxious and hazardous substance is lower than the limit of SJ/T 11363-2006

 CB PACKING BOX	Corrugated board Clapboard	 06 PS	CUSHION MATERIAL	 02 HDPE	BAG FOR MACHINE	 04 LDPE	BAG FOR PARTS
---	-------------------------------	---	------------------	---	-----------------	---	---------------

SPECIFICATIONS

Amplifier

Rated power 160W × 4 / 8Ω

Input sensitivity/impedance

KARAOKE 200mV / 22kΩ

DVD 300mV / 22kΩ

BGM 300mV / 22kΩ

MIC 17mV / 3.3kΩ

Output power

MUSIC EFFECTOR OUT 190mV / 1kΩ

SUB WOOFER (150Hz) 5.8V / 1kΩ

PRE-OUT 3.6V / 1kΩ

VIDEO OUT 1Vp-p/75Ω

Tone control of music

BASS ±10dB(100Hz)

MID ±10dB(2KHz)

TREBLE ±10dB(10KHz)

Tone control of microphone

BASS ±10dB(100Hz)

MID ±10dB(2KHz)

TREBLE ±10dB(10KHz)

Power supply

Power supply AC230V, 50Hz

Power consumption 800W

AC outlet Switched × 2
(Max. 200W)

Unswitch × 1
(Max. 100W)

Dimensions 420 × 159 × 415 mm
(W × H × D)

Weight 18.75Kg

Accessories

Operating Instructions 1

Remote Controller 1

Dry Battery 2

Power Cable 1

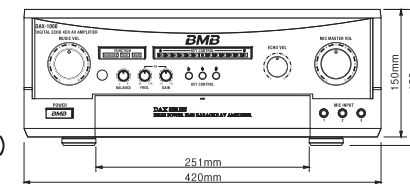
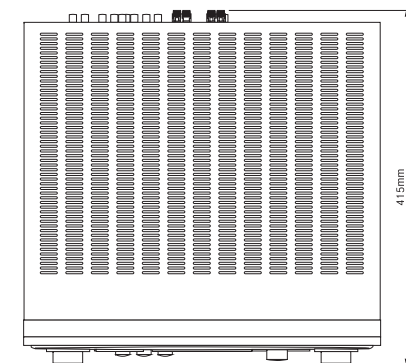

*Design and specifications shall be subject to change without any further notice.

OTHERS

Maintenance

If the surface of product is dirty, please use the clean cloth to clean the surface. If it's too dirty, you should use the soft cloth and proper amount of detergent to clean as per the proportion of 1:4~1:5 (detergent and water). After cleaning with the wet cloth, please use the dry and clean cloth to wipe again. Do not use the volatile chemical agents such as benzene. The volatile chemical agents could damage the painting on the surface.

Operating environment

1. Avoid to affect the rest of neighbors when using KARAOKE at home and note the time and place.
2. Prevent the sound from affecting others. It's advised to adopt the sound separation measures when using the product at home.
3. Turn down the volume at night and it's better if not using the product at night, for small sound would also affect the rest of others.

Property right

The broadcasting, music source such as music tape, DVD, video tape, CD and so on are strictly protected by the intellectual property right in accordance with the law of intellectual property protection. You need to have permission from the copyright holder to use, distribute, rent these music sources for commercial use, or sell dubbed media to other people except when enjoying these sources by yourself.

Product materials

The product is made from the nontoxic and hurtless materials in accordance with the relative safety rules and regulations.

CHARACTERISTICS

Major characteristics of this KARAOKE AV AMPLIFIER are as follows.

Powerful Output Force of Amplifier

The master amplifier equipped with the big power transistors has the excellent maximum output power and I.M.D in order to get ideal recovery effect and provide the perfect hearing effect.

Application of STEREO ECHO

The function of stereo echo makes the users feel as if they were at the site, and stereo echo will produce the better accompaniment effect.

Built-in Feedback Reducer

The built-in feedback reducer could effectively solve the problem of microphone howling in various environments and prevent howling.

Perfect Built-in Protective Circuit

When the overload current in the amplifier is too big or too hot and the unit of speaker has short circuit, the built-in protective circuit shall be activated automatically to effectively protect the device and speaker.

The design emphasizing the sound quality

The circuits were simplified and mutual interference was removed to reproduce the original sound and realize the high sound quality.

Convenient Volume Adjustment Function

It could adjust the volume of microphone independently and adjust the master volume and the channels of speaker respectively.

Auto Input Sound Source Selection

It could detect the external equipment automatically and select the sound source of input automatically.

PRECAUTIONS FOR INSTALLATION

Do not install the product at the following places:

- Bad ventilation or airtight environments.
- Near the heating equipments or under the direct rays of the sun.
- Unstable fields.
- Damp or dusty fields.

Right installation

The product will produce some heat in working, so it should be installed at the place where has good ventilation.

Please keep the upper side of device 10cm or more away from the wall, 5cm or more for the two sides, and 10cm or more for the rear side.

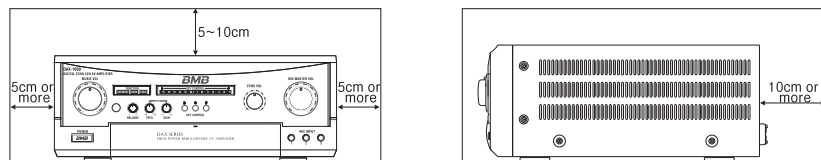

Before connecting

Precautions

When connecting, please pull off the power cable from the power socket and then reconnect. And take note the names of terminals could be different from each device.

At that moment, please refer to the instructions to connect correctly. It should use these speakers of which impedance is higher than 6Ω .

If it's connected wrongly, it might damage the device and produce noise. Noise might be produced after being installed, if the connection cable is mixed with other cable or it's too close to other electric products.

The product has two kinds of outlet in rear panel.

Outlet(switched) can be used when the switch of the amplifier is turned ON, and outlet(unswitched) can be used all the times irrespective of whether the power switch of this amplifier is ON or OFF.

Please select the proper terminal at the time of using.

Output power of AC output terminal

The output power of used audio equipment couldn't be exceeded the maximum output power. The power output terminal (AC outlet) could be used for the connection of audio equipment only. Do not use together with other electronic products (such as electric heater and other electric products of which powers are over than the nominal power).

TROUBLESHOOTING

Please refer to the following steps if the product has any trouble. And if it's unable to be solved after checking, please contact our agent or service center.

Troubles	Causes	Solutions
The amplifier has no power	The AC power cord is not connected to the amplifier. The fuse is fired.	Connect the power cord to the amplifier. Replace the fuse.
There is no sound	The speaker cable is not connected to the speaker. The volume level is too small.	Reconnect the cable to the speaker. Adjust the volume level.
There is no sound of music or microphone	The volume is too small. The connection of microphone is not good. The connection with external equipment is not good. The external equipment has troubles.	Adjust the volume. Check the connection of microphone. Check the connection port. Check and confirm whether the external equipment is working normally.
The background music is normal but the sound of microphone is too small	The volume level of microphone is too low. The master volume level of microphone is too low.	Adjust the volume level of microphone. Adjust the master volume level of microphone.
The remote controller is not working	No batteries or the battery electricity is not enough. There are the objects between the controller and the sensor.	Replace it with the new batteries. Take away the objects between the controller and the sensor.
The musical performance is turned on/off frequently	The speaker has short circuit. The unit of speaker is not good.	Check a speaker's connection. Check the unit of speaker.
The echo is too big	The distance between the microphone and speaker is too short. The sound of speaker is mixed with the sound of microphone. The treble area is too high.	Adjust the distance between the microphone and speaker. Rotate the speaker towards outside. Adjust the treble properly.
No ECHO effect in case of microphone output	The master volume of ECHO is "0".	Adjust the volume of ECHO. Adjust the master volume.

♣ When product have some problem or breakdown, please don't repair in repairing store without permission, and make sure to consult with our after-sales center or our distributor.

- Address, name and phone number
- Product name, model and purchasing date
- Faults (detailed description)
- Expected treatment time

OPERATING METHOD OF REMOTE CONTROLLER

The attached remote controller is applicable for DAX series products.

Operating range

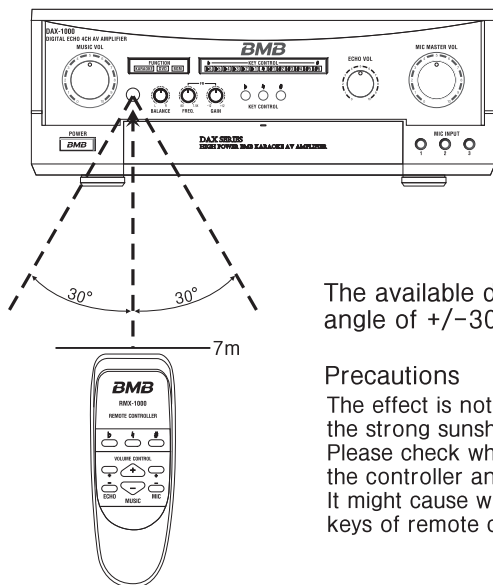

The available distance is 7 meters with the angle of +/-30 degrees.

Precautions

The effect is not good if the remote controller is under the strong sunshine. Please check whether there is any other object between the controller and the sensor. It might cause wrong operation if you press the functional keys of remote controller and device at the same time.

Method of replacing the battery

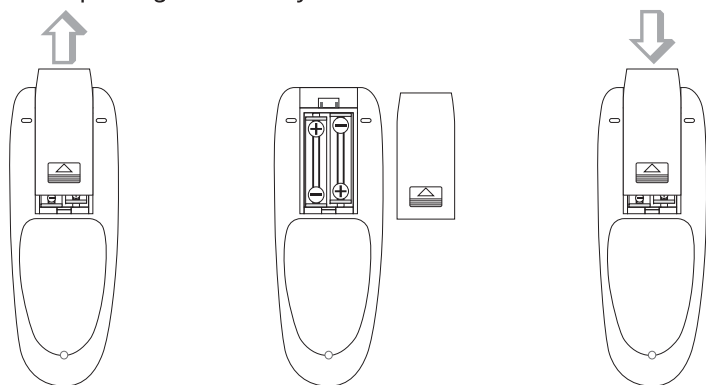

Precautions

1. If the remote controller is not so sensitive, please replace dry batteries with new ones.
2. If it's not used for a long time, please take out the dry batteries and keep them at the place out of reach of children.
3. Do not charge or heat the dry battery, for it might cause fire, blast or other accidents.

SAFETY PRECAUTIONS

Do not use the rated AC power

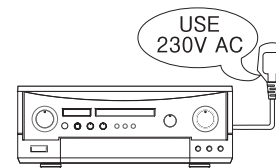

-The product should use 230V/50Hz power.

★ If the voltage is over high, it might cause fire or electric shock and other accidents.

Do not let any external object or water get into the amplifier.

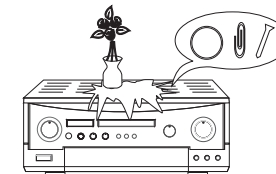

If the external object or water gets into the amplifier, it might cause fire, electric shock or other accidents. In that case, please turn off the power immediately and pull off the power plug and contact our service center as soon as possible.

Do not connect the AC power to the amplifier in the following conditions:

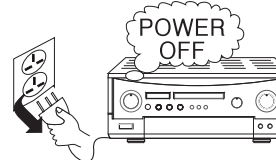

-When connecting instruments to the amplifier.
-When it's not used for a long time.
-When cleaning the product or making maintenance.

★ It might cause fire, electric shock or other accidents.

Do not damage the power cable.

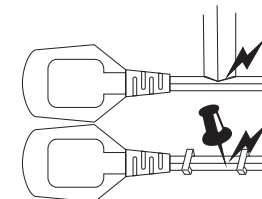

-Do not bend or pull the cable by force.
-Do not place heavy object on the cable.
-Do not change the cable by yourself.
-Do not fix the cable by bolts.

-Do not place the cable near the warming stove or air heater or other heating equipments.

★ If the cable is damaged, it might cause fire, electric shock or other accident. In such a case, please contact our agent or service center quickly.

Do not dismantle or rebuild the housing by yourself.

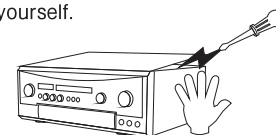

★ It might cause fire, electric shock or other accidents. If it's needed to repair or check, please contact our agent or service center.

Do not connect these equipments that use the bigger output power.

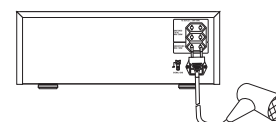

★ It might cause fire, electric shock or other accidents.

If the device gives off strange smell, smoke or abnormal sound.

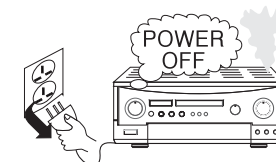

It might cause fire, electric shock or other accidents. At this moment, please turn off the power immediately and pull off the power plug, and contact our agent or service center quickly.

NAME AND FUNCTION DESCRIPTION ON THE FRONT PANEL

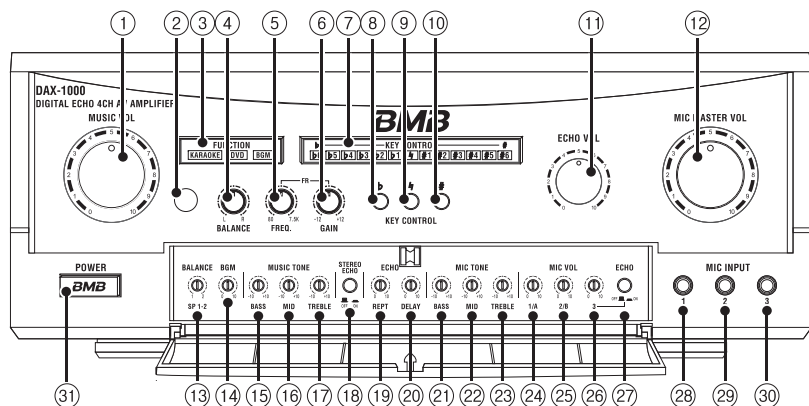

1. Music Vol control

It's used to adjust the accompanying audio device and DVD sound source signal.

2. Remote sensor

It's used to receive the signal of remote controller.

3. Input selection

The sequence of auto input mode is described as follows:

BGM → KARAOKE → DVD

It first enables BGM mode when is turned on rear function switch KARAOKE or DVD mode is selected after a few seconds if external input signal is detected from rear terminal.

If main power switch is on when rear function switch is off, KARAOKE mode is selected automatically.

4. Balance control

It's used to adjust the volume of left/right channel. The volumes of left and right channel are same when the pin is at the middle position.

5. FR frequency control (FREQ.)

FR controls of FREQ. and GAIN are used in the case the howling occurs at the of using microphone. (Refer to page 15)

6. FR gain control (GAIN)

Refer to page 15.

7. Indicator

The LED indicator will flicker when turning on the amplifier and will light at the time of pressing the reset button.

8. Key control button (down)

Press the button once to make pitch (b) down one by one.

9. Reset button

When rising pitch (#) or falling scale (b), press the reset button to return to the initial pitch.

10. Key control button (up)

Press the button once to make pitch (#) up one by one.

11. Echo Vol control

It's used to adjust the entire echo and effect level of MIC INPUTs 1, 2, 3 and MICs A and B (rear).

12. MIC Master Vol control

It's used to adjust the overall microphone input level.

DETAILED OPERATING METHOD

Operating method of key controller

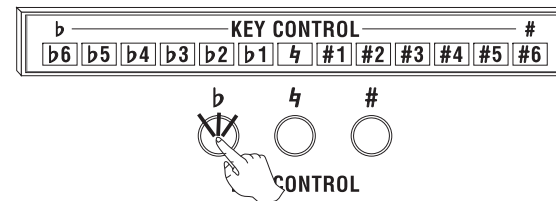

- b** 1. Press the button once to decrease the pitch one level by level. It could adjust in the range of b 1~b 6, and b 6 is the lowest pitch. After the music is over, it shall return to the initial sound effect in 4 seconds.
- b1 → b2 → b3 → b4 → b5 → b6
- 4** Press reset key to return to the initial sound.
- #** 1. Press the button once to increase the pitch one level by level. It could adjust in the range of #1~#6, and #6 is the highest pitch.
2. After the music is over, it shall return to the initial sound effect in 4 seconds.
- #1 → #2 → #3 → #4 → #5 → #6
- ♣ It might cause fault or wrong operation if pressing the two or more buttons at the same time.

Usage of FR

Sound quality can be corrected by adjusting FR when the howling is generated after adjusting the volume and sound quality of MUSIC and MIC (TONE : BASS, MID, TREBLE) according to preference.

1. Set FREQ. volume and GAIN volume of FR to the center.

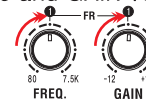

2. Set GAIN volume to the position of -12.

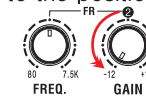

3. Turn FREQ. Volume to the left (direction of 80Hz) or the right (direction of 7.5k Hz) slowly in order to look for the appropriate frequency in which howling becomes small.

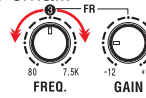

4. Adjust GAIN volume to the level without howling.

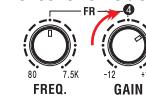

BASIC OPERATION

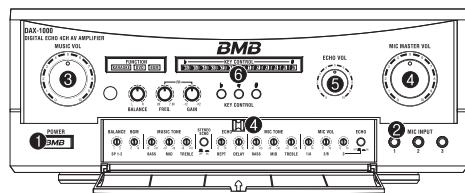

1. Turn on the power switches of the amplifier and other equipments.
2. Connect the required quantity of microphone to the amplifier.
3. Set the music source equipment to the play mode, and then arrange the MUSIC VOL control of the amplifier to the necessary level.
4. Control the balance of mic input and the level of the music source by adjust MIC VOL control(MIC1/A, 2/B, and 3/MC) and MIC MASTER VOL.
5. Adjust the echo level as required.
6. Adjust the pitch by pressing the key control buttons.
The required setting was finished and other equipments should not be adjusted anymore. Then, set the music source equipment only.

Operating method of microphone

1. It's advised to keep the microphone 5-10cm away from your mouth.
2. If the microphone is too close to mouth or hold the microphone head, it might produce noise or echo.

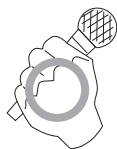

About the protective circuit

The product has built-in overload current protection and overheat protective device, which could effectively protect the speaker in case of short circuit.

After activating the protective circuit, the device shall automatically cut off the output of speaker and the indicators of microphone and master volume shall flacker at the same time.

At that time, you must pull off the power plug and check the connection of speaker plug and other plugs.

If the device is too hot, improve the ventilation and do not connect the power plug until the temperature is decreased.

Input mode

After the device is connected with the external equipments, it shall automatically display the input mode selecting interface. There are three input terminals (KARAOKE, DVD and BGM), and the initial mode is KARAOKE.

NAME AND FUNCTION DESCRIPTION ON THE FRONT PANEL

13. L-R Balance control
It's used to adjust the volume of left/right speaker.
The volumes of right and left speakers are same when the pin is at the middle position.
14. BGM Vol control
If the external device or the accompanying audio device is used, and if there is blank part after the track is over, it could adjust the volume of background music.
15. Music tone control (Bass)
It's used to adjust the accompanying audio device and the bass volume in playing DVD. It could be adjusted in the range of -10~+10dB.
16. Music tone control (Middle)
It's used to adjust the accompanying audio device and the middle volume in playing DVD. It could be adjusted in the range of -10~+10dB.
17. Music tone control (Treble)
It's used to adjust the accompanying audio device and the treble volume in playing DVD. It could be adjusted in the range of -10~+10dB.
In general conditions, it could adjust the bass, middle and treble through the standard level (0).
If it adjusts too much, it might damage the speaker and produce echo.
18. Stereo echo switch
It's used to select the mono/stereo echo. When the user selects the mono, the same echo affected sound of microphone shall be produced from left/right speakers respectively.
When the stereo selected, microphone shall be spread from the left/right speakers.
19. Echo control (Repeat)
It's used to adjust the echo sustaining duration.
20. Echo control (Delay)
It's used to adjust the echo's repetition intervals.
21. Mic tone control (Bass)
It's used to adjust the bass effects of microphones that are connected with the terminals.
It could be adjusted in the range of -10~+10dB.
22. Mic tone control (Middle)
It's used to adjust the middle effects of microphones that are connected with the terminals.
It could be adjusted in the range of -10~+10dB.
23. Mic tone control (Treble)
It's used to adjust the treble effects of microphones that are connected with the terminals.
It could be adjusted in the range of -10~+10dB.
24. Mic Vol control (1/A)
It's used to adjust the output volume of front microphone 1 and the rear MIC A.
25. Mic Vol control (2/B)
It's used to adjust the output volume of front microphone 2 and the rear MIC B.
26. Mic Vol control (3)
It's used to adjust the output volume of front microphone 3.
27. Echo on/off switch
It could set up the echo effect of microphone 3.
After turning on this switch, it could add the echo effect in the sound effect of microphone; and when turning off this switch, it could output the microphone sound only and turn off all echo effects.
28. 29. 30. Microphone input jacks
The jacks connecting with microphones.
31. Power switch
Press the power switch to turn on the power and further press to turn off the power.
*Please check which is better between "jack" and "terminal" on all the seat onces.

NAME AND FUNCTION DESCRIPTION ON THE REAR PANEL

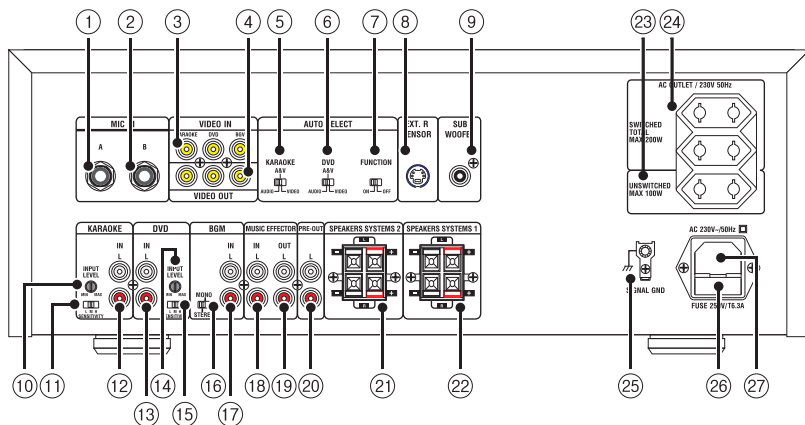

1. Microphone A input jack

It's used to connect the jack of microphone.
It's mainly used in case that it's difficult to connect the front panel.

2. Microphone B input jack

It's used to connect the jack of microphone.
It's mainly used in case that it's difficult to connect the front panel.

3. Video input jack

It's used to connect the jack of accompanying audio device or DVD video output device.

4. Video output jack

It's used to output the video of accompanying audio device or DVD to the terminal of display.

5. KARAOKE audio/video select switch

Select audio and video signal of KARAOKE player.

6. DVD audio/video select switch

Select an audio and video signal of DVD.

7. Auto input select switch (ON/OFF)

This switch automatically enables or disables a function mode selected according to sound source signal detected from equipped external instruments of rear panel. KARAOKE mode is fixed automatically when function switch is off. The system selects a mode according to the sequence of sound source signal from equipped external instruments of rear panel. And switches a mode to BGM if no signal.

8. EXT(ernal) remote sensor terminal

If the device is installed at such a place where the remote controller is not available, you can control and operate the device by connecting the external remote control terminal with the IR input terminal.

9. Output terminal of subwoofer

In order to enhance the effect of bass, you can connect on active subwoofer for driving super low frequency (super low frequency=under 50Hz) or built-in amplifier via the output terminal.

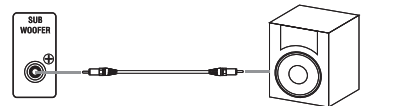

Output terminal

Active sub woofer

SETUP OF MOTOR VOLUME OUTPUT ADJUSTMENT

If the user may set up the max. output levels of the master volume of music and microphone, it may effectively protect the speaker and the amplifying circuit. The method of setting up the max. output level is described as follows:

1. Remove the knob of the master volume of music and microphone.
※Precautions for removing the knob
The knob and the LED is connected by the cable, so that you should pull it out carefully.
2. Remove the bolts first and then fix them on the corresponding positions again.
If the bolts are too tight, it might cause bad effect. Please keep the bolts at the consistence height with the original position or confirm whether the knob is fixed firmly.
3. Please use the same specification bolts.
Improper bolts might cause disconnection and it's easy to fall into the machine, and it would damage the knob hole.
4. Adjust the knob clockwise to increase the level of volume, and adjust the knob counterclockwise to decrease the level of volume.

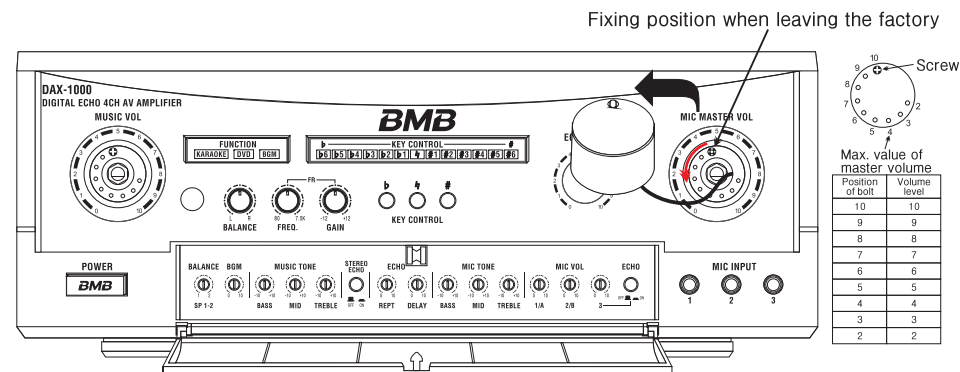

DOOR OPENING/CLOSING

1. Press A part to open the door, and reverse operation to close the door.
2. The controls of microphone, music, echo effect, BGM and speaker are equipped at the inner side of door.
3. In order to facilitate to operate at the dark place, the light shall be turned on automatically when opening the door and turned off when closing the door.
4. After operating the controls inside the door, please close the door.

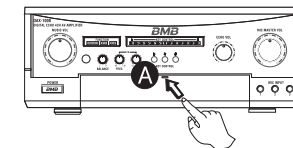

* Note

If too big force is made at B direction, it might damage the structure. so operate properly.

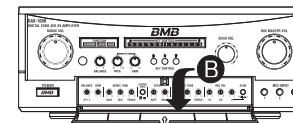

PRECAUTIONS FOR CONNECTION

When connecting the speaker cable

When connecting the speaker connector, please confirm the right polarities (+ and -) and the right channel, and do not connect reversely. Please pay attention to the connection of speaker and avoid touching with other terminals or the rear panel. In addition, do connect the cable according to the correct polarities and avoid the touch of naked speaker cables.

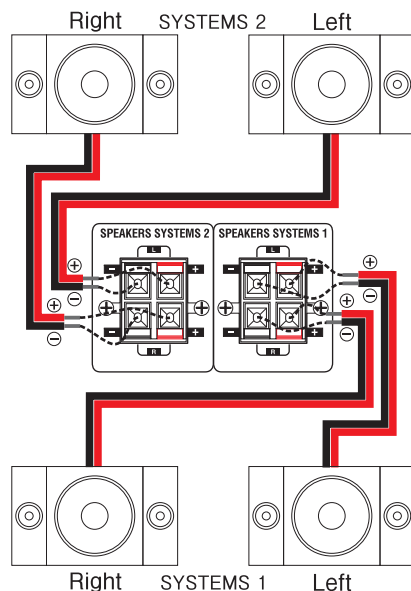
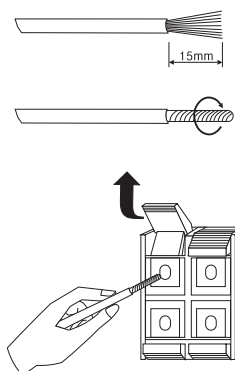

About the impedance of speaker

If a speaker that has lower impedance than the rated impedance (6~8 ohms), for example 4 ohms speaker, is used for a long time, the built-in protective circuit may be activated automatically. After the protective circuit is activated, pull off the cable and keep a good ventilation to reduce the temperature and then reconnect the power.

When connecting the signal cable

When connecting the signal cable, after pulling off the power cable, please confirm the left plug (L: white) and right plug (R: red) and then connect them. The names of the terminals could be different with the device. Please read and refer to the operating instructions to ensure correct connection. If the signals of left plug and right plug are connected reversely, the stereo effect shall be reduced.

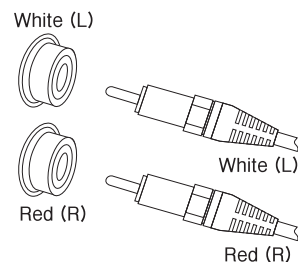

NAME AND FUNCTION DESCRIPTION ON THE REAR PANEL

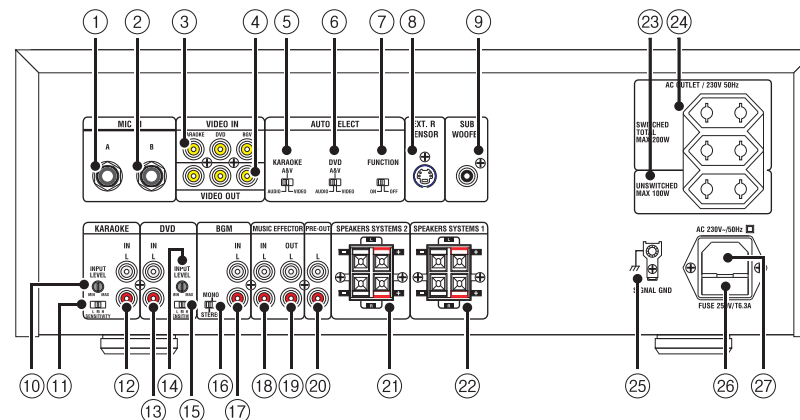

10. KARAOKE input level control
When the KARAOKE input signal level is too big or too small, it could be adjusted through KARAOKE input level control.
11. KARAOKE sensitivity switch
Set the sensitivity at which KARAOKE audio input level is detected and switched automatically.
12. KARAOKE audio input jacks
It's used to connect the output jack of accompanying audio device (KARAOKE device).
13. DVD audio input jacks
It's used to connect the output jack of DVD.
14. DVD input level control
When the DVD input signal level is too big or too small, it could be adjusted through DVD input level control.
15. DVD sensitivity switch
Set the sensitivity at which DVD audio input level is detected and switched automatically.
16. BGM mono/stereo select switch
Select the BMG signal input mode between mono and stereo through this switch.
17. BGM audio input jacks
It's used to connect the output terminal of BGM (back ground music) device.
18. Music effector input jacks
In order to enhance the music effect of accompanying audio device or DVD, it's used to connect the output terminal of sound effect adjustor.
19. Music effector output jacks
In order to enhance the music effect of accompanying audio device or DVD, it's used to connect the input terminal of sound effect adjustor.
20. Pre-output terminal
In order to enhance the output of speaker, when using the external amplifier, the pre-output terminal of this amplifier could be connected with the input terminal of the external amplifier.

NAME AND FUNCTION DESCRIPTION ON THE REAR PANEL

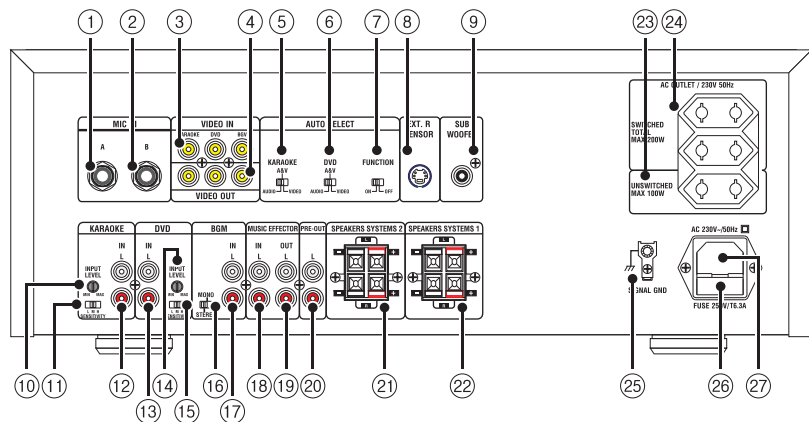

★Note:

When it's needed to connect the external amplifier, please turn off both of this amplifier and external amplifier first and confirm whether the volume control is at the smallest status, and then connect. Too big output level might damage the product and the speaker.

The max. rated power of the output terminal is 200W. Do not use the bigger rate equipments.

21. Speakers systems connectors 2

It's used to connect the terminal of speaker 2. Please refer to page 11 for the connection.

25. Signal grounding terminal

It is recommended to ground this amplifier order to prevent this amplifier from electric shock or noise from other equipment. If grounding is provided, trouble with unknown cause may be remedied. But if the place is wet or it's not good for grounding connection, it might cause fault, electric shock, fire or other accidents.

22. Speakers systems connectors 1

It's used to connect the terminal of speaker 1. Please refer to page 11 for the connection.

26. Fuse

There is the fuse inside the fuse cover. Please use the same specification product when replacing the fuse.

23. AC outlet (Unswitched)

Power is supplied to the connected equipment at all times irrespective of whether the power switch of this amplifier is ON or OFF. The max. rated power of the output terminal is 100W. Do not use the bigger rate equipments.

27. AC input

The product uses 230V/50Hz AC voltage. Please insert the power cable into the socket after connecting the terminal.

24. AC outlet (Switched)

Power is supplied to the connected equipment when the power switch of this amplifier is turned ON.

★Precautions

Please use the attached power cable when connecting. It might cause fire or damage if other kinds of cables are used.

CONNECTION DIAGRAM OF EXTERNAL EQUIPMENTS

