

OWNER'S MANUAL

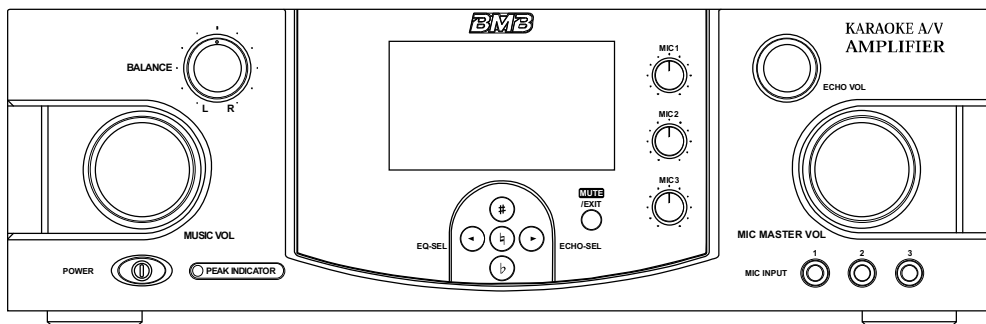

Thank you very much for purchasing our KARAOKE A/V AMPLIFIER. Prior to use, be sure to read this owner's manual from cover to cover so that you can make the most out of this unit. The manual will come in handy whenever you come across any question or trouble while using the unit.

CONTENTS

USING THE UNIT SAFELY.....	2	BASIC OPERATION	12
IMPORTANT NOTES.....	5	AUDIO/VIDEO SIGNAL DETECTION MODE.....	13
SPECIAL FEATURES.....	6	VIDEO SWITCHING	13
BEFORE CONNECTION.....	6	SETTING MODE.....	13
NAMES OF FRONT PANEL CONTROLS AND THEIR FUNCTIONS	7	TROUBLESHOOTING	14
NAMES OF REAR PANEL CONTROLS AND THEIR FUNCTIONS	8	AFTER-SALE SERVICING	15
SYSTEM CONNECTIONS.....	10	MANNERS FOR CUSTOMERS.....	15
CONNECTIONS	11	COPYRIGHT.....	15
		ABOUT THE PRODUCT.....	15
		SPECIFICATIONS	16

USING THE UNIT SAFELY



• ABOUT THE SAFETY SYMBOLS



The lightning flash with arrowhead symbol, within equilateral triangle, is intended to alert the user to the presence of uninsulated "dangerous voltage" within the product's enclosure that may be of sufficient magnitude to constitute a risk of electric shock to persons.



The exclamation point within an equilateral triangle is intended to alert the user to the presence of important operating and maintenance (servicing) instructions in the literature accompanying the appliance.

INSTRUCTIONS FOR THE PREVENTION OF FIRE, ELECTRIC SHOCK, OR INJURY TO PERSONS

About **▲ WARNING** and **▲ CAUTION** Notices

▲ WARNING	Used for instructions intended to alert the user to the risk of death or severe injury should the unit be used improperly.
▲ CAUTION	Used for instructions intended to alert the user to the risk of injury or material damage should the unit be used improperly. * Material damage refers to damage or other adverse effects caused with respect to the home and all its furnishings, as well to domestic animals or pets.

About the Symbols

	The ▲ symbol alerts the user to important instructions or warnings. The specific meaning of the symbol is determined by the design contained within the triangle. In the case of the symbol at left, it is used for general cautions, warnings, or alerts to danger.
	The symbol alerts the user to items that must never be carried out (are forbidden). The specific thing that must not be done is indicated by the design contained within the circle. In the case of the symbol at left, it means that the unit must never be disassembled.
	The symbol alerts the user to things that must be carried out. The specific thing that must be done is indicated by the design contained within the circle. In the case of the symbol at left, it means that the power supply cable plug must be unplugged from the outlet.

-----ALWAYS OBSERVE THE FOLLOWING-----

▲ WARNING

Do not disassemble or modify by yourself

Do not open (or modify in any way) the unit or its power supply cable.



Do not repair or replace parts by yourself

Do not attempt to repair the unit, or replace parts within it (except when this manual provides specific instructions directing you to do so). Refer all servicing to your retailer.



Do not use or store in the following types of locations

- Subject to temperature extremes (e.g., direct sunlight in an enclosed vehicle, near a heating duct, on top of heat-generating equipment); or are
- Damp (e.g., baths, washrooms, on wet floors); or are
- Exposed to steam or smoke; or are
- Subject to salt exposure; or are
- Humid; or are
- Exposed to rain; or are
- Dusty or sandy; or are
- Subject to high levels of vibration and shakiness; or are
- In a place near cooking utensils where the unit may be subjected to soot, smoke, fume or heat.



Do not place in an unstable location

Make sure you always have the unit placed so it is level and sure to remain stable. Never place it on stands that could wobble, or on inclined surfaces.



Use only the supplied power cord

Use only the attached power-supply cord. Also, the supplied power cord must not be used with any other device.



Do not bend the power cord or place heavy objects on it

Do not excessively twist or bend the power cord, nor place heavy objects on it. Doing so can damage the cord, producing severed elements and short circuits. Damaged cords are fire and shock hazards!



Avoid extended use at high volume

This unit in combination with speakers may be capable of producing sound levels that could cause permanent hearing loss. Do not operate for a long period of time at a high volume level, or at a level that is uncomfortable. If you experience any hearing loss or ringing in the ears, you should immediately stop using the unit, and consult an audiologist.



The lightning flash with arrowhead symbol is intended to alert the user to the presence of uninsulated "dangerous voltage" within the product's enclosure that may be of sufficient magnitude to constitute a risk of electric shock to persons.



⚠ WARNING

Don't allow foreign objects or liquids to enter unit; never place containers with liquid on unit

Do not place containers containing liquid on this product. Never allow foreign objects (e.g., flammable objects, coins, wires) or liquids (e.g., water or juice) to enter this product. Doing so may cause short circuits, faulty operation, or other malfunctions.



Turn off the unit if an abnormality or malfunction occurs

Immediately turn the unit off, remove the power supply cable from the outlet, and request servicing by your retailer:

- The power supply cable, or the plug has been damaged; or
- If smoke or unusual odor occurs; or
- Objects have fallen into, or liquid has been spilled onto the unit; or
- The unit has been exposed to rain (or otherwise has become wet); or
- The unit does not appear to operate normally or exhibits a marked change in performance.



Adults must provide supervision in places where children are present

When using the unit in locations where children are present, be careful so no mishandling of the unit can take place. An adult should always be on hand to provide supervision and guidance.



Do not drop or subject to strong impact

Protect the unit from strong impact. (Do not drop it!)



⚠ WARNING

Do not share an outlet with an unreasonable number of other devices

Do not force the unit's power-supply cord to share an outlet with an unreasonable number of other devices. Be especially careful when using extension cords-the total power used by all devices you have connected to the extension cord's outlet must never exceed the power rating (watts/amperes) for the extension cord. Excessive loads can cause the insulation on the cord to heat up and eventually melt through.



Check the voltage of your local mains supply

The power cord should not be connected to a direct current (DC).



The apparatus shall be connected to a MAINS socket outlet with a protective earthing connection.



The external wiring connected to Speaker terminals requires installation by an instructed person or the use of ready made leads or cords.



Use this unit at an elevation lower than 2,000 meters.



⚠ WARNING

Keep these instructions.



Heed all warnings.



Follow all instructions.



Do not block any ventilation openings. Install in accordance with the manufacturer's instructions.



Do not install near any heat sources such as radiators, heat registers, stoves, or other apparatus (including amplifiers) that produce heat.



Do not defeat the safety purpose of the polarized or grounding-type plug. A polarized plug has two blades with one wider than the other. A grounding type plug has two blades and a third grounding prong. The wide blade or the third prong are provided for your safety. If the provided plug does not fit into your outlet, consult an electrician for replacement of the obsolete outlet.



Protect the power cord from being walked on or pinched particularly at plugs, convenience receptacles, and the point where they exit from the apparatus.



Use only with the cart, stand, tripod, bracket, or table specified by the manufacturer, or sold with the apparatus. When a cart is used, use caution when moving the cart/apparatus combination to avoid injury from tip-over.



Unplug this apparatus during lightning storms or when unused for long periods of time.



To reduce the risk of fire or electric shock, do not expose this apparatus to rain or moisture.



⚠ CAUTION

Place in a well ventilated location

The unit should be located so their location or position does not interfere with their proper ventilation.



Manage cables for safety

Try to prevent cords and cables from becoming entangled. Also, all cords and cables should be placed so they are out of the reach of children.



Avoid climbing on top of the unit, or placing heavy objects on it

Never climb on top of, nor place heavy objects on the unit.



⚠ CAUTION

Do not connect or disconnect the power cord with wet hands

Never handle the power supply cable or its plugs with wet hands when plugging into, or unplugging from, an outlet or this unit.



Disconnect everything before moving the unit

Before moving the unit, disconnect the power supply cable and all cords coming from external devices.



Unplug the power cord from the outlet before cleaning

Before cleaning the unit, turn it off and unplug the power supply cable from the outlet .



Unplug the power cord from the outlet before repairing

Before repairing the unit, turn it off and unplug the power supply cable from the outlet.



Keep small items out of the reach of children

To prevent accidental ingestion, always keep them out of the reach of small children.



When unusing the unit for an extended period of time

When you leave your home for a long period of time, turn OFF the power and remove the power supply cable from the AC outlet. This will prevent from unexpected accident and fire.



The apparatus shall not be exposed to dripping or splashing and that no objects filled with liquids, such as vases, shall be placed on the apparatus.



Where the MAINS plug or an appliance coupler is used as the disconnect device, the disconnect device shall remain readily operable.



These servicing instructions are for use by qualified service personnel only. To reduce the risk of electric shock do not perform any servicing other than that contained in the operating instructions unless you are qualified to do so.



IMPORTANT NOTES

■ Power Supply

- Do not connect this unit to same electrical outlet that is being used by an electrical appliance that is controlled by an inverter or a motor (such as a refrigerator, washing machine, microwave oven, or air conditioner). Depending on the way in which the electrical appliance is used, power supply noise may cause this unit to malfunction or may produce audible noise. If it is not practical to use a separate electrical outlet, connect a power supply noise filter between this unit and the electrical outlet.
- To prevent malfunction and equipment failure, always make sure to turn off the power on all your equipment before you make any connections.

■ Placement

- Using the unit near other equipment containing large power transformers may induce hum. To alleviate the problem, change the orientation of this unit; or move it farther away from the source of interference.
- This device may interfere with radio and television reception. Do not use this device in the vicinity of such receivers.
- Noise may be produced if wireless communications devices, such as cell phones, are operated in the vicinity of this unit. Such noise could occur when receiving or initiating a call, or while conversing. Should you experience such problems, you should relocate such wireless devices so they are at a greater distance from this unit, or switch them off.
- Do not expose the unit to direct sunlight, place it near devices that radiate heat, leave it inside an enclosed vehicle, or otherwise subject it to temperature extremes. Excessive heat can deform or discolor the unit.
- When moved from one location to another where the temperature and/or humidity is very different, water droplets (condensation) may form inside the unit. Damage or malfunction may result if you attempt to use the unit in this condition. Therefore, before using the unit, you must allow it to stand for several hours, until the condensation has completely evaporated.
- Depending on the material and temperature of the surface on which you place the unit, its rubber feet may discolor or mar the surface. You can place a piece of felt or cloth under the rubber feet to prevent this from happening. If you do so, please make sure that the unit will not slip or move accidentally.
- Do not put anything that contains water on this unit. Also, avoid the use of insecticides, perfumes, alcohol, nail polish, spray cans, etc., near the unit. Swiftly wipe away any liquid that spills on the unit using a dry, soft cloth.

■ Maintenance

- For everyday cleaning wipe the unit with a soft, dry cloth or one that has been slightly dampened with water. To remove stubborn dirt, use a cloth impregnated with a mild, non-abrasive detergent. Afterwards, be sure to wipe the unit thoroughly with a soft, dry cloth.
- Never use benzine, thinners, alcohol or solvents of any kind, to avoid the possibility of discoloration and/or deformation.

■ Additional Precautions

- Use a reasonable amount of care when using the unit's buttons, sliders, or other controls; and when using its jacks and connectors. Rough handling can lead to malfunctions.
- Never strike or apply strong pressure to the display.
- When disconnecting all cables, grasp the connector itself—never pull on the cable. This way you will avoid causing shorts, or damage to the cable's internal elements.
- When you need to transport the unit, package it in the box (including padding) that it came in, if possible. Otherwise, you will need to use equivalent packaging materials.
- Some connection cables contain resistors. Do not use cables that incorporate resistors for connecting to this unit. The use of such cables can cause the sound level to be extremely low, or impossible to hear. For information on cable specifications, contact the manufacturer of the cable.

■ Copyrights / Licenses / Trademarks

- It is forbidden by law to make an audio recording, video recording, copy or revision of a third party's copyrighted work (musical work, video work, broadcast, live performance, or other work), whether in whole or in part, and distribute, sell, lease, perform, or broadcast it without the permission of the copyright owner.
- Do not use this product for purposes that could infringe on a copyright held by a third party. We assume no responsibility whatsoever with regard to any infringements of third-party copyrights arising through your use of this product.
- Company names and product names appearing in this document are registered trademarks or trademarks of their respective owners.

SPECIAL FEATURES

- Ultra high performance professional digital power amplifier.
- Multiple ways of system configuration;
DAS-300
300W mode: 300W × 2CH
 Front SYSTEM (300W) + Rear
 SYSTEM (300W)
150W mode: 150W × 2CH × 2 SYSTEM (4CH)
DAS-150
150W × 2CH
- It has a echo of six types. It can be selected to match the melody.
- Three input channel functions are automatically selected in the preset priority sequence.
- It is equipped with the equalizer of 10 Bands. It can be set separately music and microphone.
- Effector terminal which permits connection of a graphic equalizer.
- Five microphones can be used simultaneously, one of which independently permits ON/OFF of echo for use by an emcee (MC).
- Low impedance compatible power amplifier configuration that can drive two pairs of speakers individually.
- A ±6-position key controller that can vary up to 3.0 pitch (chromatic intervals) is incorporated.
- Multi-function LCD display that enables displaying and setting of equalizer input , echo, etc.
- PEAK INDICATOR indicates peak level to prevent overhead saturation.

BEFORE CONNECTION









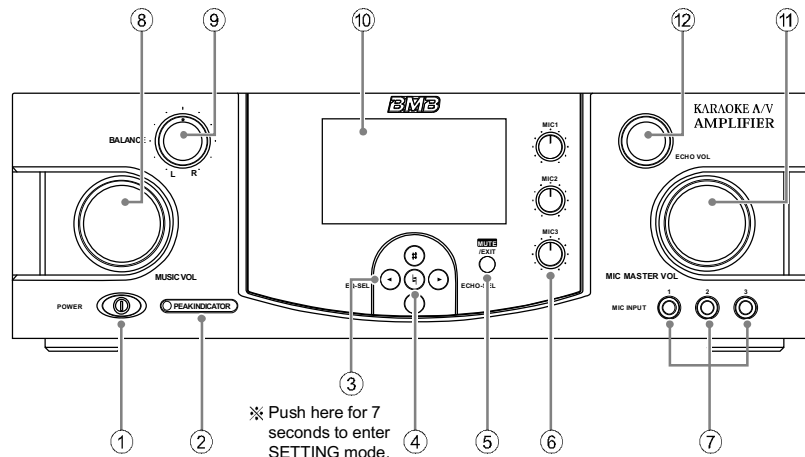







■ Cautions and warnings

- When making connections, do so with the power to the unit switched OFF.
- As for the input and output jacks on the amplifier, "white" denotes left channel whereas "red" right channel. Firmly make connections in correct left and right channels.
- Connect cord plugs firmly. Improper connection may lead to no sound output or to generation of noise.
- When disconnecting the power supply cable from the outlet, be sure to hold its plug.

NAMES OF FRONT PANEL CONTROLS AND THEIR FUNCTIONS

FRONT PANEL (DAS-300/DAS-150)



- ① **POWER switch (ON  /OFF )**
Press to turn ON the power. Press this again to turn it OFF.
The product is still connected to power supply, even if the power switch is OFF.
- ② **PEAK INDICATOR**
Indicates the output power.
When the output power is too high, the PEAK INDICATOR lights. Reduce the volume level by adjusting MUSIC VOL and MIC MASTER VOL, and adjusting the setting value of MAX for MUSIC VOL and MIC MASTER VOL at setting interface.
- ③ **/// (UP/DOWN/LEFT/RIGHT) buttons**
Press each button to enter your desired interface.
⏪: Select the EQ mode at the Top interface.
⏩: Select the Echo mode at the Top interface.
Note: To increase the pitch, press the  button.
To lower the pitch, press the  button.
- ④ ** ENTER button**
Press this button to confirm the interface that you have just selected.
Note: Pressing this button also allows the standard pitch to be resumed.
- ⑤ **MUTE/EXIT button**
When the unit is in use, press this button to mute. During setting, press this button to return to the previous interface.
- ⑥ **MIC 1/, MIC 2/, MIC 3 knobs**
MIC 1/: Adjust the input levels of MIC INPUT 1 and MIC  (Rear).
MIC 2/: Adjust the input levels of MIC INPUT 2 and MIC  (Rear).
MIC 3: Adjust the input level of MIC INPUT 3.
Note: When Mic 3 Echo is set to OFF, use by an emcee is enabled.
- ⑦ **MIC INPUT 1, 2, 3 jacks**
Microphone input jacks.
- ⑧ **MUSIC VOL knob**
Adjust the volume of the equipment connected to the audio input terminals.
- ⑨ **BALANCE knob**
Adjust the balance between the right and left channel levels output from the speakers.
- ⑩ **LCD Display**
Display various interfaces.
- ⑪ **MIC MASTER VOL knob**
Adjust the overall microphone input volume level.
- ⑫ **ECHO VOL knob**
Adjust the entire echo and effect level of MIC INPUTs 1, 2, 3 and MIC , MIC  (Rear).

NAMES OF REAR PANEL CONTROLS AND THEIR FUNCTIONS

REAR PANEL

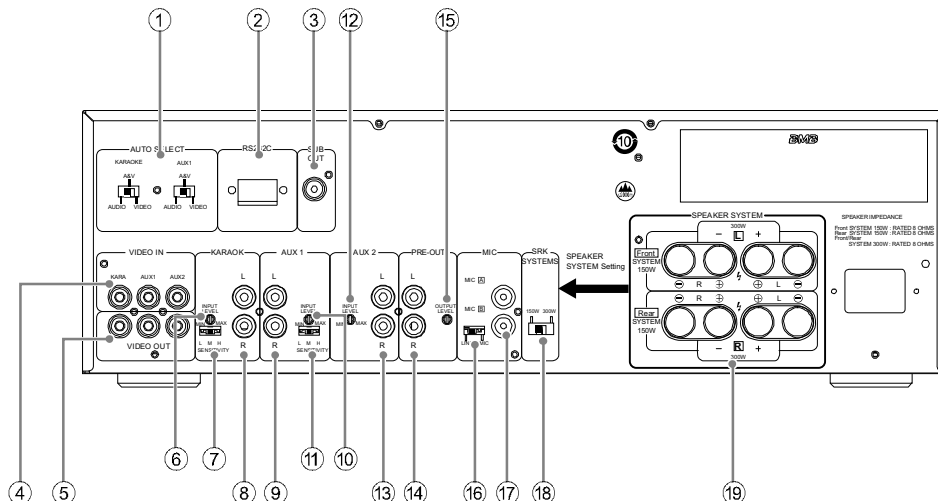

① AUTO SELECT switches

KARAOKE

Depending on the switch position, the detection mode will be switched from among the three modes, Audio, A&V or VIDEO.

AUX 1

Depending on the switch position, the detection mode will be switched from among the three modes, Audio, A&V or VIDEO.

② RS232C serial port

Input commands for remote control.

③ SUB OUT jack

Connect the jack of the amplifier of sub woofer.

④ VIDEO IN jacks

KARA: Connect the video output jack of the KARAOKE unit here.

AUX 1: Connect the output jack of external video source equipment here.

AUX 2: Connect the output jack of external video source equipment here.

⑤ VIDEO OUT jacks

Up to three TV monitors can be connected to these video output jacks.

⑥ KARAOKE INPUT LEVEL control

Adjust this control by balancing with the level of inputs .

⑦ KARAOKE SENSITIVITY switch

Set the sensitivity at which KARAOKE audio input level is detected and switched automatically.

L(ow): Set to this position when the function does not change to other mode even if KARAOKE play is over.

M(id): Set to this position in normal operating conditions.

H(igh): Set to this position when function changes to other mode during KARAOKE play.

⑧ KARAOKE jacks

Connect the audio output jack of the KARAOKE unit.

⑨ AUX 1 jacks

Connect the audio output jacks of external audio source equipment here.

⑩ AUX 1 INPUT LEVEL control

Adjust this control by balancing with the level of inputs .

⑪ **AUX 1 SENSITIVITY switch**

Set the sensitivity at which AUX 1 audio input level is detected and switched automatically.

L(ow): Set to this position when the function does not change to other mode even if AUX 1 play is over.

M(id): Set to this position in normal operating condition.

H(igh): Set to this position when the function changes to other mode during AUX 1 play.

⑫ **AUX 2 INPUT LEVEL control**

Adjust this control by balancing with the level of inputs.

⑬ **AUX 2 jacks**

Connect the audio output jacks of external audio source equipment here.

⑭ **PRE-OUT jacks**

Output terminals for use in connecting a power amplifier.

⑮ **PRE-OUT OUTPUT LEVEL control**

Adjust this control by balancing with the level of power amplifier.

⑯ **MIC/LINE switch**

Set this switch to MIC to enable MIC A and MIC B.

Set this switch to LINE to connect other microphone lines.

Note: Please reduce the volume of MIC MASTER VOL or press the MUTE/EXIT key to mute before setting the switch.

⑰ **MIC , MIC  jacks**

Jack A is a mixing input jack with MIC INPUT 1 on the front panel whereas jack B is a mixing input jack with MIC INPUT 2.

⑱ **SPK SYSTEM switch (Only for DAS-300)**

300W: The speaker system can be driven at 300W by Front SYSTEM or Rear SYSTEM separately.

150W: The speaker system can be driven at 150W by Front SYSTEM (L/R), or Rear SYSTEM (L/R).

Note: DAS-150 is not equipped with this switch.

⑲ **SPEAKER SYSTEMS connectors**

Connectors to which speakers with a nominal impedance of 8Ω.

Please see page 10 for more information.

SYSTEM CONNECTIONS

■ DAS-300

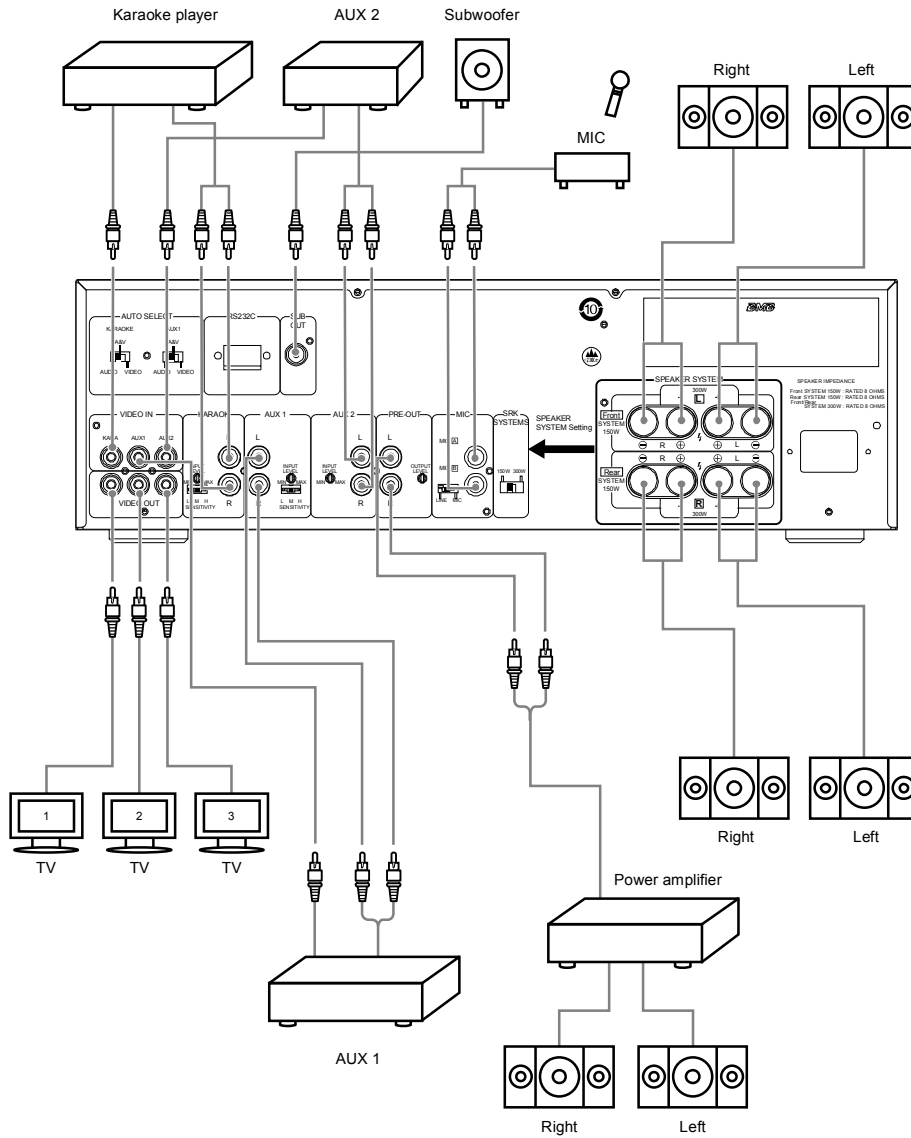

■ DAS-150

1. SPEAKER CONNECTIONS

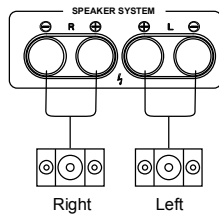

2. The connection method of other jacks is similar to that of DAS-300, but no SPK SYSTEM switch.

CONNECTIONS

How to connect speaker cords

1. Loosen the speaker terminals.
2. Insert the stripped end of the cord from upside.
3. Tighten the speaker terminals.

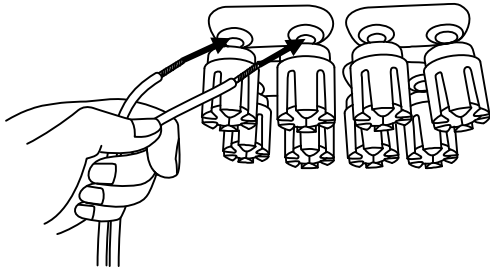

Note: For DAS-300, insert the stripped end of the cord from downside.

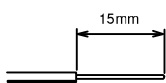

Strip about 15 mm of the outer covering from the ends of the cords by using the pliers before making connections.

How to connect RCA pin plugs

- When connecting RCA pin plug cords, match the colors. Connect red cord to red jack and white to white.

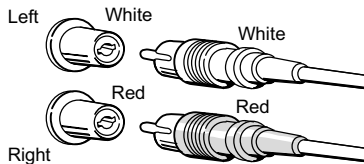

Cautions:

- See that wire frays (straggly conductors) are not sticking out of the speaker connectors. If the wire frays come into contact with other conductors, it may lead to failure of the unit.
- Use speakers with a nominal impedance of 8Ω .
- If speakers with an impedance lower than 8Ω are connected, the protective circuit may go into operation, defeating normal stereo playback.
- When the 300W setting is on, use speakers with a nominal impedance of 8Ω and note the connection.

DAS-150

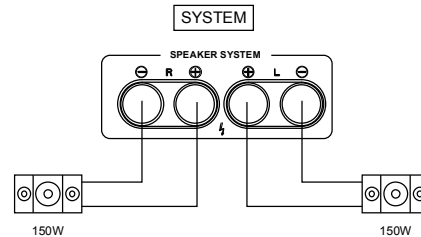

DAS-300

300W Mode Setting

Set the switch position to "300W" in the beginning.

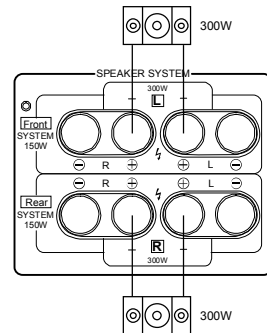

150W Mode Setting

Set the switch position to "150W" in the beginning.

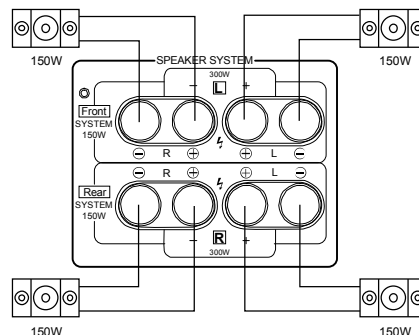

Note: When stereo speakers (4CH) are enabled, please adjust each volume to obtain proper balance of each SYSTEMS, L and R channels.

BASIC OPERATION

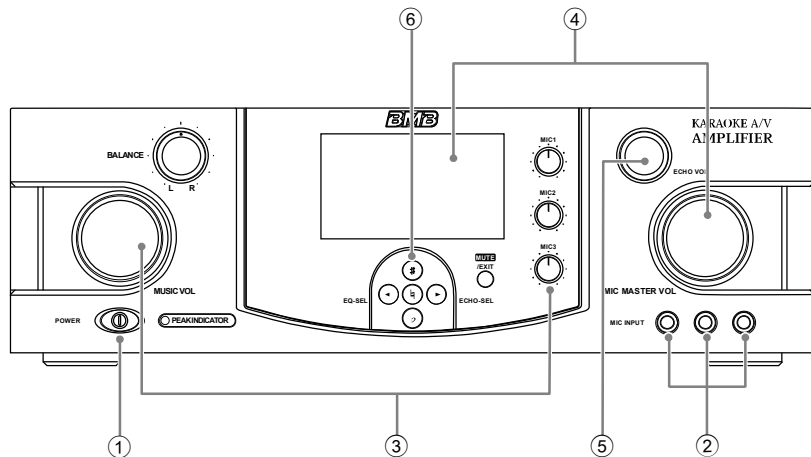

- ① Depress the power switch of this unit and other equipment.
- ② Connect the required number of microphones.
- ③ Set the KARAOKE machine to the play mode, then set the MUSIC VOL knob to the required level.
- ④ Turn the MIC VOL knobs and MIC MASTER VOL knob to balance the level with that of music source.

Note:

If the PEAK INDICATOR lights, input level is too high, then reduce the input level by adjusting MUSIC VOL, or MIC MASTER VOL knobs.

- ⑤ Adjust the echo level as required.
- ⑥ Adjust the pitch using the key control buttons.

Now that the required setting is finished, you do not have to operate this unit. All you need to do is to operate the music source equipment.

■ **How to use microphones properly and operating precautions**

- Keep the microphone approx. 5 to 10 cm away from your mouth.
- To make the voice sound clearly, leave the proper space between the microphone head and holding position on the microphone.
- Do not cover the lower wind screen of the microphone. As this may muffle the bass sound, defeating proper vocal reproduction. It may also cause howling.

(1) Provide a space of approx. 5 to 10 cm.

(2) Leave the proper space.

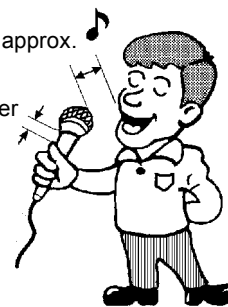

- When you use the IR microphone system, do not cover or shade the IR radiation parts (black plastic window) of microphone at the bottom as the wireless signal is weakened.
- Do not use the microphone toward the speaker as it may cause the feedback (howling).

AUDIO/VIDEO SIGNAL DETECTION MODE

As for the KARAOKE and AUX 1 functions, the detection mode will be switched from among the three modes (AUDIO, A&V or VIDEO) depending on the position of the AUTO SELECT switches on the rear panel.

■ **When the switch is set to "AUDIO"**

- The audio input is detected.

■ **When the switch is set to "VIDEO"**

- The video input is detected.

■ **When the switch is set to "A&V"**

- Either the audio input or video input is detected.

VIDEO SWITCHING

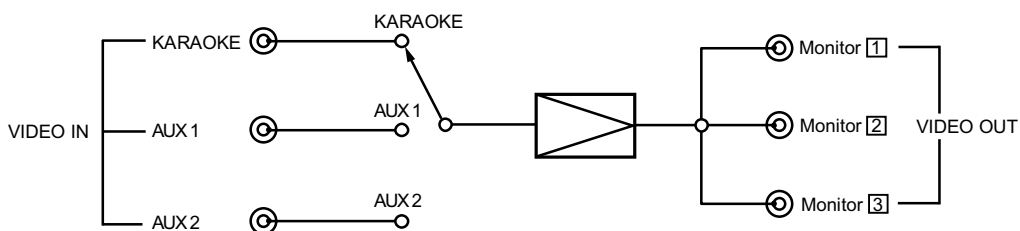

SETTING MODE

Push here for "7 seconds" to enter SETTING mode.

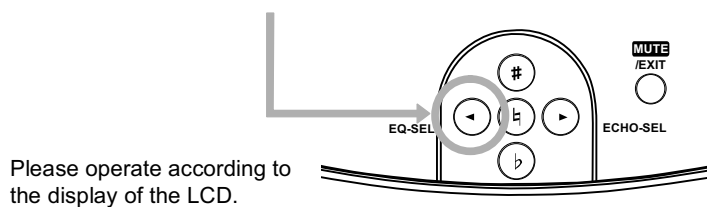

TROUBLESHOOTING

Trouble	Possible cause	Remedy
No power is supplied to the unit.	<ul style="list-style-type: none"> The power plug is disconnected from the power outlet. 	<ul style="list-style-type: none"> Firmly connect the power plug to the power outlet.
Power ON but no sound.	<ul style="list-style-type: none"> Music Volume control or Mic Volume control may be set to minimum. 	<ul style="list-style-type: none"> Adjust for the proper sound level.
	<ul style="list-style-type: none"> The speaker cables are disconnected. 	<ul style="list-style-type: none"> Connect the speaker cables properly.
	<ul style="list-style-type: none"> Break in the speaker cables. 	<ul style="list-style-type: none"> Repair the break in the cables.
	<ul style="list-style-type: none"> Speaker cables are short - circuited. 	<ul style="list-style-type: none"> Repair the short - circuit.
	<ul style="list-style-type: none"> Equipment to be connected are disconnected. 	<ul style="list-style-type: none"> Properly connect the equipment.
No sound at beginning of the music when switching function.	<ul style="list-style-type: none"> Sensitivity switch is set to "Low". 	<ul style="list-style-type: none"> Set the Sensitivity switch to "high".
	<ul style="list-style-type: none"> Output level of audio component is set to minimum. 	<ul style="list-style-type: none"> Adjust it for suitable level if it has a level control.
No sound from microphone (but music is played back).	<ul style="list-style-type: none"> Microphone switch is set to OFF. 	<ul style="list-style-type: none"> Set it to ON.
	<ul style="list-style-type: none"> Break in the microphone cord. 	<ul style="list-style-type: none"> Repair or replace it.
	<ul style="list-style-type: none"> The microphone plug is disconnected. 	<ul style="list-style-type: none"> Connect it properly.
No video.	<ul style="list-style-type: none"> VIDEO OUT jacks are not fully connected. 	<ul style="list-style-type: none"> Firmly insert TV monitor plug into VIDEO OUT jack.
	<ul style="list-style-type: none"> VIDEO IN jacks are not fully connected. 	<ul style="list-style-type: none"> Firmly insert plugs into VIDEO IN jacks.
No audio is played back even if CD or LD audio signal is input.	<ul style="list-style-type: none"> AUTO SELECT switches are set to VIDEO. 	<ul style="list-style-type: none"> Set AUTO SELECT switches to AUDIO or A&V.
Playback picture does not appear even if CD or LD signal is input.	<ul style="list-style-type: none"> AUTO SELECT switches are set to AUDIO. 	<ul style="list-style-type: none"> Set AUTO SELECT switches to VIDEO or A&V.
Function is switched to AUX 2 while playing KARAOKE or AUX 1.	<ul style="list-style-type: none"> Input sensitivity of KARAOKE or AUX 1 is low. 	<ul style="list-style-type: none"> Set SENSITIVITY switches to H.
No audio is played back even if KARAOKE or AUX 1 audio signal is input.	<ul style="list-style-type: none"> AUTO SELECT switches are set to VIDEO. 	<ul style="list-style-type: none"> Set AUTO SELECT switches to AUDIO or A&V.
Play back picture does not appear even if KARAOKE or AUX 1 signal is input.	<ul style="list-style-type: none"> AUTO SELECT switches are set to AUDIO. 	<ul style="list-style-type: none"> Set AUTO SELECT switches to VIDEO or A&V.

AFTER-SALE SERVICING

- (1) If this unit is found to be defective, your local dealer will repair or replace defective parts with charge at your request.
- (2) Before you request the repair to your local dealer, see the "TROUBLESHOOTING" section and check it again.

For dealer :

If you are requested the after-sale service from your customer, check the following contents first.

- Confirming the details of the accident.
- Checking out all cables and connections.
- Clean the lens or the disc of which connected equipment.
- Caution of operation and instruction for using the system to your customer.

MANNERS FOR CUSTOMERS

- Karaoke, though enjoyable, could be noisy at times unless proper time and place are chosen. Please be sufficiently thoughtful of your neighbors.



- Karaoke volume could be high if you are engrossed in singing. Even a small sound can be penetrating especially at quiet night. Therefore, please give special attention to audio level especially at night. As no sound leaks to your neighbors, it is advisable to close the windows and observe proper manners to maintain pleasant living environment.

COPYRIGHT

- Broadcasting, music source such as recorded music tape, DVD, video tape, CD and so on are strictly protected under copyright law.
- You need to have permission from the copyright holder to use, distribute, rent these music sources for commercial use, or sell dubbed media to other people except when enjoying these sources by yourself.

ABOUT THE PRODUCT

- This unit is produced by harmless materials in conformity with relevant product safety laws.

SPECIFICATIONS

DAS-300/DAS-150 KARAOKE AMPLIFIER

		DAS-300	DAS-150
Audio output power		150W+150W+150W+150W(4ch) 300W+300W(2ch)	150W+150W
Speaker impedance		Rated 8 Ω	
Input impedance	MIC1-MIC3	3.3kΩ	
	MICA/MICB	3.3kΩ	
	Audio Input (KARAOKE,AUX1,AUX2)	4.7k Ω (middle position)	
	Video Input (KARAOKE,AUX1,AUX2)	75Ω	
Output impedance	Pre-Out	1kΩ	
	Sub-Out	1kΩ	
	Video Output	75Ω	
Nominal input level	MIC1-MIC3	10mV	
	MICA/MICB	10mV (Gain setting: MIC) 1Vpp(Gain setting: LINE)	
	Audio Input (KARAOKE,AUX1,AUX2)	1Vpp	
	Video Input (KARAOKE,AUX1,AUX2)	1Vpp	
Nominal output level	Pre-Out	1Vpp	
	Sub-Out	1Vpp	
Video format		NTSC,PAL	
Connectors	Speaker Terminal (Black&Red)	4	2
	Front panel MIC input	3	
	Rear panel MIC input	2	
	KARAOKE Audio input Jack (L&R)	1	
	AUX1 Audio input Jack (L&R)	1	
	AUX2 Audio input Jack (L&R)	1	
	VIDEO INPUT JACK	3	
	VIDEO OUTPUT JACK	3	
	PRE-Out audio output jack (L&R)	1	
	SUB-Out audio output jack	1	
	Remote control port (RS232)	1	
	Display		4.3 inch TFT LCD display 420(W)×135(H)×335(D)
Dimensions			
Gross Weight		14kg	12kg
Net Weight		12.5kg	10.5kg
Power supply		100:AC110-120V, 200:AC220-240V 50/60 Hz	
Power consumption		650W	350W



For EU Countries

This product complies with the requirements of EMC Directive 2004/108/EC.

For the USA

FEDERAL COMMUNICATIONS COMMISSION RADIO FREQUENCY INTERFERENCE STATEMENT

This equipment has been tested and found to comply with the limits for a Class A digital device, pursuant to part 15 of the FCC Rules. These limits are designed to provide reasonable protection against harmful interference when the equipment is operated in a commercial environment. This equipment generates, uses, and can radiate radio frequency energy and, if not installed and used in accordance with the instruction manual, may cause harmful interference to radio communications. Operation of this equipment in a residential area is likely to cause harmful interference in which case the user will be required to correct the interference at his own expense.

This device complies with Part 15 of the FCC Rules. Operation is subject to the following two conditions:

- (1) this device may not cause harmful interference, and
- (2) this device must accept any interference received, including interference that may cause undesired operation.

For Canada

NOTICE

This Class A digital apparatus meets all requirements of the Canadian Interference-Causing Equipment Regulations.

AVIS

Cet appareil numérique de la classe A respecte toutes les exigences du Règlement sur le matériel brouilleur du Canada.

For C.A. US (Proposition 65)

WARNING

This product contains chemicals known to cause cancer, birth defects and other reproductive harm, including lead.

For the USA

DECLARATION OF CONFORMITY Compliance Information Statement

Model Name : DAS-300 / DAS-150
 Type of Equipment : KARAOKE AMPLIFIER
 Responsible Party : ACE KARAOKE CORP.
 Address : 161 S. 8th Ave., City of Industry, CA 91746, USA
 Telephone : +1-626-600-5366

For Korea

A급 기기 (업무용 방송통신기기)

이 기기는 업무용(A급)으로 전자파적합 등록을 한 기기이오니 판매자 또는 사용자는 이점을 주의하시기 바라며, 가정외의 지역에서 사용하는 것을 목적으로 합니다.

BMB

BMB International Corp.
<http://www.bmb.com>