

## OWNER'S MANUAL

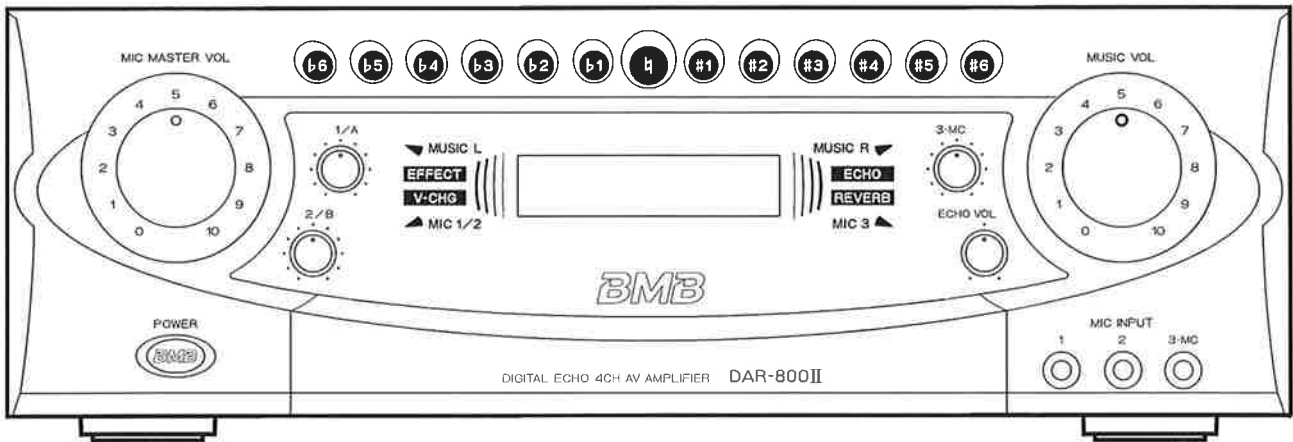

Thank you very much for purchasing our DIGITAL ECHO 4CH AV AMPLIFIER. Prior to use, be sure to read this owner's manual from cover to cover so that you can make the most out of this unit. The manual will come in handy whenever you come across any question or trouble while using the unit.

### CONTENTS

|  |    |  |    |
|--|----|--|----|
| IMPORTANT SAFETY PRECAUTIONS .....   | 2  | DOOR LOCKING.....                      | 13 |
| IMPORTANT SAFETY PRECAUTIONS .....   | 3  | BASIC OPERATION.....                   | 14 |
| SPECIAL FEATURES.....  | 4  | ECHO/EFFECT OPERATION .....            | 15 |
| PRECAUTIONS FOR HANDLING .....   | 4  | AUTO/VIDEO SIGNAL DETECTION MODE ..... | 16 |
| BEFORE CONNECTION.....   | 4  | VIDEO SWITCHING .....                  | 16 |
| SAFETY PRECAUTIONS .....   | 5  | REMOTE CONTROL OPERATION.....          | 17 |
| NAMES OF FRONT-PANEL CONTROLS AND<br>THEIR FUNCTIONS.....  | 6  | TROUBLE SHOOTING .....                 | 18 |
| NAMES OF REAR-PANEL CONTROLS AND<br>THEIR FUNCTIONS.....   | 8  | MAINTENANCE.....                       | 20 |
| SYSTEM CONNECTIONS.....  | 11 | AFTER-SALE SERVICING .....             | 20 |
| CONNECTIONS .....  | 12 | MANNERS FOR CUSTOMERS.....             | 20 |
| MECHANISM TO PREVENT EXCESSIVE VOLUME<br>LEVELS OF MIC MASTER VOL CONTROL AND<br>MUSIC VOL CONTROL ..... | 13 | COPY RIGHT .....                       | 20 |
|  |    | ABOUT THE PRODUCT .....                | 20 |
|  |    | SPECIFICATIONS .....                   | 21 |

# IMPORTANT SAFETY PRECAUTIONS



CAUTION: TO REDUCE THE RISK OF ELECTRIC SHOCK, DO NOT REMOVE COVER (OR BACK). NO USER-SERVICEABLE PARTS INSIDE. REFER SERVICING TO QUALIFIED SERVICE PERSONNEL.



The lightning flash with arrowhead symbol, within equilateral triangle, is intended to alert the user to the presence of uninsulated "dangerous voltage" within the product's enclosure that may be of sufficient magnitude to constitute a risk of electric shock to persons.



The exclamation point within an equilateral triangle is intended to alert the user to the presence of important operating and maintenance (servicing) instructions in the literature accompanying the appliance.

This appliance has a serial number located on the rear panel. Please record the model number and serial number and retain them for your records.

Model number \_\_\_\_\_  
Serial number \_\_\_\_\_

**WARNING: TO PREVENT FIRE OR SHOCK HAZARD, DO NOT EXPOSE THIS APPLIANCE TO RAIN OR MOISTURE.**

For U.S.A.

TO THE USER

This equipment has been tested and found to comply with the limits for a Class B digital device, pursuant to Part 15 of the FCC Rules. These limits are designed to provide reasonable protection against harmful interference in a residential installation. This equipment generates, uses, and can radiate radio frequency energy and, if not installed and used in accordance with the instruction manual, may cause harmful interference to radio communications.

However, there is no guarantee that interference will not occur in a particular installation. If this equipment does cause harmful interference to radio or television reception, which can be determined by turning the equipment off and on, the user is encouraged to try to correct the interference by one or more of the following measures.

- a) Reorient or relocate the receiving antenna.
- b) Increase the separation between the equipment and receiver.
- c) Connect the equipment into an outlet on a circuit different from that to which the receiver is connected.
- d) Consult the dealer or an experienced radio/TV technician for help.

## CAUTION

Changes or modifications to this equipment not expressly approved by BMB Corp. for compliance could void the user's authority to operate this equipment.

# IMPORTANT SAFETY PRECAUTIONS

---

- 1 Read these instructions.
  - 2 Keep these instructions.
  - 3 Heed all warnings.
  - 4 Follow all instructions.
  - 5 Do not use this apparatus near water.
  - 6 Clean only with dry cloth.
  - 7 Do not block any ventilation openings. Install in accordance with the manufacturer's instructions.
  - 8 Do not install near any heat sources such as radiators, heat registers, stoves, or other apparatus (including amplifiers) that produce heat.
  - 9 Do not defeat the safety purpose of the polarized or grounding-type plug. A polarized plug has two blades with one wider than the other. A grounding type plug has two blades and a third grounding prong. The wide blade or the third prong are provided for your safety. If the provided plug does not fit into your outlet, consult an electrician for replacement of the obsolete outlet.
  - 10 Protect the power cord from being walked on or pinched particularly at plugs, convenience receptacles, and the point where they exit from the apparatus.
  - 11 Only use attachments/accessories specified by the manufacturer.
  - 12 Use only with the cart, stand, tripod, bracket, or table specified by the manufacturer, or sold with the apparatus. When a cart is used, use caution when moving the cart/apparatus combination to avoid injury from tip-over.
- Do not expose this apparatus to drips or splashes.
  - Do not place any objects filled with liquids, such as vases, on the apparatus.
  - Do not install this apparatus in a confined space such as a book case or similar unit.
  - The apparatus draws nominal non-operating power from the AC outlet with its POWER switch in the off position.
  - The apparatus should be located close enough to the AC outlet so that you can easily grasp the power cord plug at any time.
  - An apparatus with Class I construction shall be connected to an AC outlet with a protective grounding connection.



- 13 Unplug this apparatus during lightning storms or when unused for long periods of time.
- 14 Refer all servicing to qualified service personnel. Servicing is required when the apparatus has been damaged in any way, such as power-supply cord or plug is damaged, liquid has been spilled or objects have fallen into the apparatus, the apparatus has been exposed to rain or moisture, does not operate normally, or has been dropped.

# SPECIAL FEATURES

---

- Ultra high performance digital power amplifiers (4CH).
- 3 ways of system configuration;  
BTL: **360W + 360W (8Ω)** stereo amplifier  
SYSTEM 1+2 : Two sets of stereo speakers (4CH)  
**150W x 2 (8Ω) + 150W x 2 (8Ω)**  
SYSTEM 1 : One set of stereo speakers (2CH)  
**150W x 2 (8Ω)**
- Ultra Hi-speed DSP for multi effectors (8 effectors) and feedback reducing function is also equipped.
- Five input channel functions are automatically selected in the preset priority sequence.
- Easy-to-sing high-performance digital echo.
- Effector terminal which permits connection of a graphic equalizer.
- Five microphones can be used simultaneously, one of which independently permits ON/OFF of echo for use by an emcee (MC).
- Low impedance compatible **power** amplifier configuration that can **drive two pairs of speakers individually**.
- A  $\pm 6$ -position key controller that can vary up to 3.0 pitch (chromatic intervals) is incorporated. At the end of a tune, the standard pitch is resumed automatically.
- A wireless remote control which permits remote control of music volume, microphone volume, echo level, key control, echo select and voice change.
- Multi-function blue LCD-display indicates input position, effectors, and massage.
- The peak indicator of MIC 1/2, MIC 3 and MUSIC L&R input indicates peak level to prevent overhead saturation.

# PRECAUTIONS FOR HANDLING

---

## ■ Avoid placing the unit in the following places:

- Where there is direct sunlight or near a heating body such as a heater.
- Where ventilation is poor so heat is trapped or there is plenty of humidity or dust.
- An unstable place which is subjected to vibrations or inclination.
- A place near window where rain may splash onto the unit.
- A place near cooking utensils where the unit may be subjected to soot, smoke, fume or heat.

# BEFORE CONNECTION

---

## ■ Cautions and warnings

- When making connections, do so with the power to the unit switched OFF.
- As for the input and output jacks on the amplifier, "white" denotes left channel whereas "red" right channel. Firmly make connections in correct left and right channels.
- Connect cord plugs firmly. Improper connection may lead to no sound output or to generation of noise.
- When disconnecting the power cord from the outlet, be sure to hold its plug.

## ■ Power consumption of the AC OUTLETS

- See that the power consumption does not exceed the wattage shown on the rear panel. Do not connect any unit other than the system equipment to the AC OUTLETS on the rear of this unit.
- **Do not connect a TV monitor as it may draw a large current and its wattage may exceed the allowable value** when the power is switched ON, even if the value indicated on the TV monitor is smaller than the allowable wattage for this unit.

# SAFETY PRECAUTIONS

## Check the voltage of your local mains supply



Singapore: AC230V

Malaysia : AC240V

The power cord should not be connected to a direct current (DC).

## If malfunction occurs



If malfunction occurs, such as noise in the sound or odor from the unit, remove the power cord from the AC outlet and stop using the unit immediately and consult your local dealer.

## Do not disassemble the unit

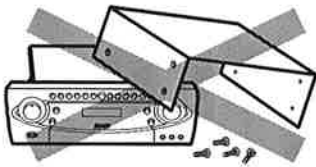

Do not attempt to modify, repair, or disassemble the unit, as opening or removing covers may expose you to dangerous voltage or other hazards. There are no user serviceable parts inside. If the unit has a problem or breakdown in case of you attempt to modify the unit, quality of the unit can not be guaranteed.

## When you leave your home or installation location

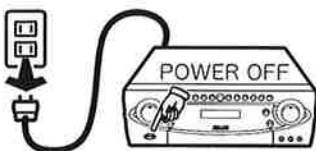

When you leave your home for a long period of time, turn OFF the power and remove the power cord from the AC outlet. This will prevent from unexpected accident and fire.

## Avoid push or drop any object or liquid into the unit

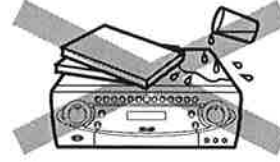

Never push or drop any kind of objects into this unit through openings as they may touch dangerous voltage points or short-circuit parts that could result in a fire or electric shock. Never spill any kind of liquid on this unit. If some object/liquid has been dropped, remove the power cord from AC outlet and consult your local dealer.

## Do not damage the Power Cord



When remove the power cord from AC outlet, always grasp and pull the plug, not the power cord. Damage to the power cord may cause short-circuit or shock hazard. Power cord should not be routed to under furniture or where it may be likely damaged.

## Do not overload the AC outlet on the unit

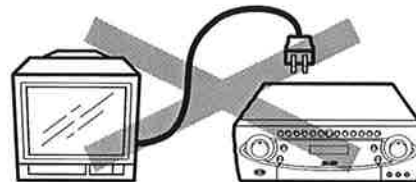

This unit provides AC outlet which can be connected to the system source components. Do not overload the AC outlet on the unit. If power consumption exceeds over the indicated on the rear panel, this can result in fire or other hazard. The outlet should not be used for connections of TVs in which may exceed in a moment over the indicated wattage.

# NAMES OF FRONT-PANEL CONTROLS AND THEIR FUNCTIONS

## FRONT PANEL

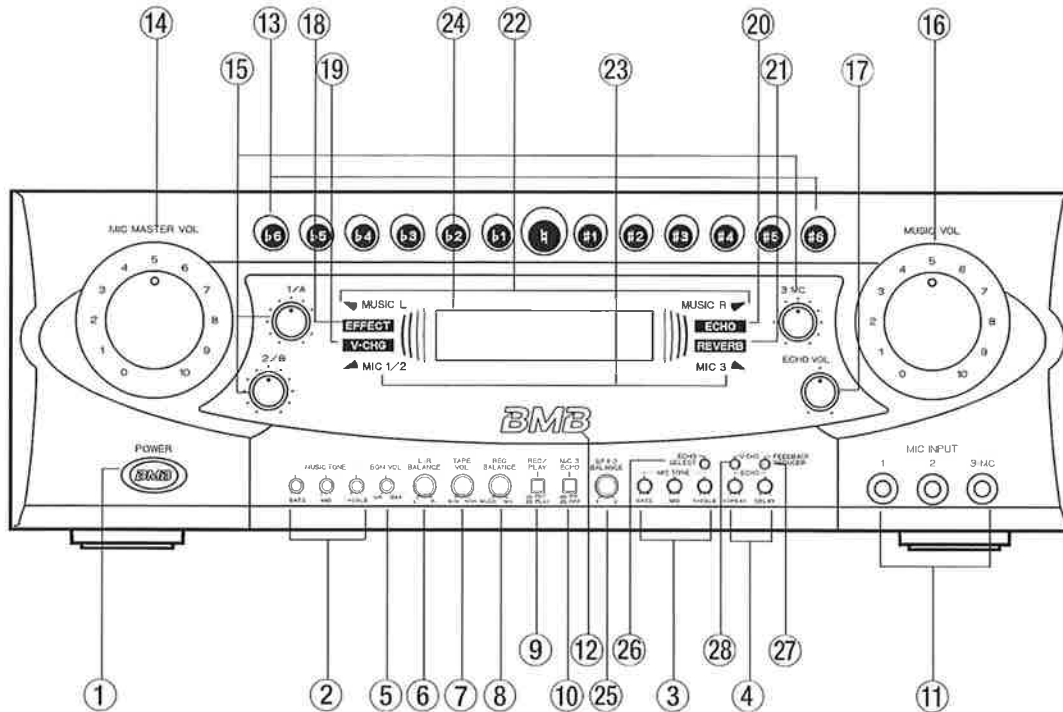

**① POWER switch (ON  /OFF )**

Press to turn ON the power. Press this again to turn it OFF.

**② MUSIC TONE controls (BASS/MID/TREBLE)**

Adjust the music input by boosting low, middle or high frequency, respectively.

**③ MIC TONE controls (BASS/MID/TREBLE)**

Adjust the microphone input by boosting low, middle or high frequency, respectively.

**④ ECHO controls (REPEAT/DELAY)**

REPEAT: Adjust the echo sustaining duration.  
DELAY: Adjust the echo's repetition intervals.

**⑤ BGM VOL control**

Adjust the BGM to an optimum level.

**⑥ L-R BALANCE control**

Adjust the balance between the right and left channel levels output from the speakers.

**⑦ TAPE VOL control**

Adjust the "TAPE" playback volume level.

**⑧ REC BALANCE control**

Adjust the balance between music source and microphone sound during recording.

**⑨ REC/PLAY selector switch (REC  / PLAY )**

Press this switch to REC () when recording sound on a tape, and to PLAY () when playing a tape (to prevent oscillation, be sure to set to REC when recording sound).

**⑩ 3-MC/ECHO switch (ON  /OFF )**

Press this switch to ON when effecting echo to the third microphone (for use by an emcee) input.

**⑪ MIC INPUT jacks (1, 2, 3-MC)**

Microphone input jacks.

**⑫ REMOTE control sensor**

Receive the signal from the provided wireless remote control unit (RMR-800).

### ⑬ KEY control buttons

Press the required button when changing the pitch of a song. The buttons can vary the pitch in plus/minus six steps with each button varying the pitch in chromatic interval with respect to the standard pitch. The selected pitch is indicated by the change in color of the pressed button (when play of a song is over, the standard pitch resumes automatically).

### ⑭ MIC MASTER VOL control

Adjust the overall microphone input volume level.

### ⑮ MIC VOL controls (1/A, 2/B, 3-MC)

1 / A: Adjust the input levels of MIC INPUT 1 and MIC A (on the rear panel).

2 / B: Adjust the input levels of MIC INPUT 2 and MIC B (on the rear panel).

3-MC: Adjust the input level of MIC INPUT 3-MC.

- In normal use, it is recommended to set the level to maximum.

### ⑯ MUSIC VOL control

Adjust the volume of the equipment connected to the audio input terminals (This control does not change the BGM volume. To change its volume level, use the BGM VOL control).

### ⑰ ECHO VOL control

Adjust the entire echo and effect level of MIC INPUTs 1, 2, 3-MC and MICs A and B (rear).

### ⑱ EFFECT: Effect Mode Indicator

Indicator for any effector is selected.

### ⑲ V- CHG: Vocal Change Indicator

Indicator as vocal change is selected.

### ⑳ ECHO: Echo Indicator

Indicator as echo is selected.

### ㉑ REVERB: Reverb Indicator

Indicator as reverb is selected.

### ㉒ MUSIC Input peak indicator

Indicate Input peak level of MUSIC (Left and Right).

### ㉓ MIC Input peak indicator

Indicate peak input level of MIC-1/2/A (Left), MIC-3/B (Right) (Peak position: -3dB)

### ㉔ LCD Display

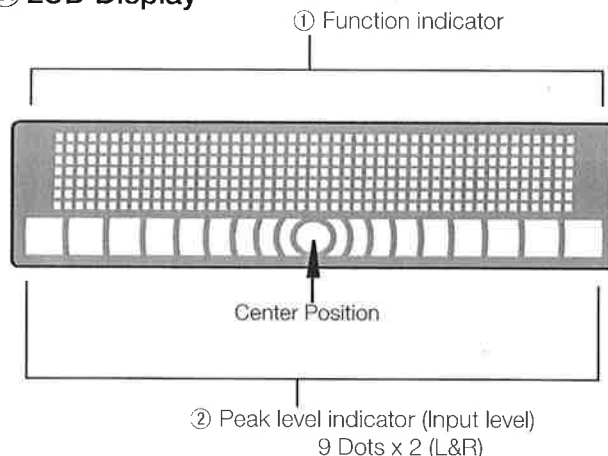

#### ① Function indicator

Indicate each function or situation as bellow:

Input position, Effectors, Feedback reducer, Voice Change (V-CHG), and Error message.

#### ② Peak level indicators

Indicate input level of left and right channel (9 dots/CH and Center dot).

### ㉕ SP 1-2 BALANCE

Adjust the balance of output level between SYSTEM1 and SYSTEM2. Please refer to page 12 for more information.

1. Speakers from SYSTEM1 (BTL mode: L CH)
2. Speakers from SYSTEM2 (BTL mode: R CH)

### ㉖ ECHO SELECT switch

Press this switch to select preferable effectors, and the selected effectors will be indicated on LCD display.

Echo →REV →MIX →

### ㉗ FEEDBACK REDUCER (ON/OFF)

Press this switch to reduce howling (feedback) by searching howling point and filtering them.

#### CAUTION:

If feedback reducer could not work sufficiently, check the MIC, speaker's position and sound level by moving or changing the position/angle of speaker unit, not to affect feedback to the MIC.

### ㉘ V-CHG selector switch

Press this switch when selecting Voice Change effectors. Indicate LCD of selected Voice Change effectors.

#### NOTE:

For more information about ⑱, ⑲, ⑳, ㉑, ㉒, ㉓, ㉔, ㉕, ㉖, ㉗ and ㉘, please refer to page 15.

# NAMES OF REAR-PANEL CONTROLS AND THEIR FUNCTIONS

## REAR PANEL

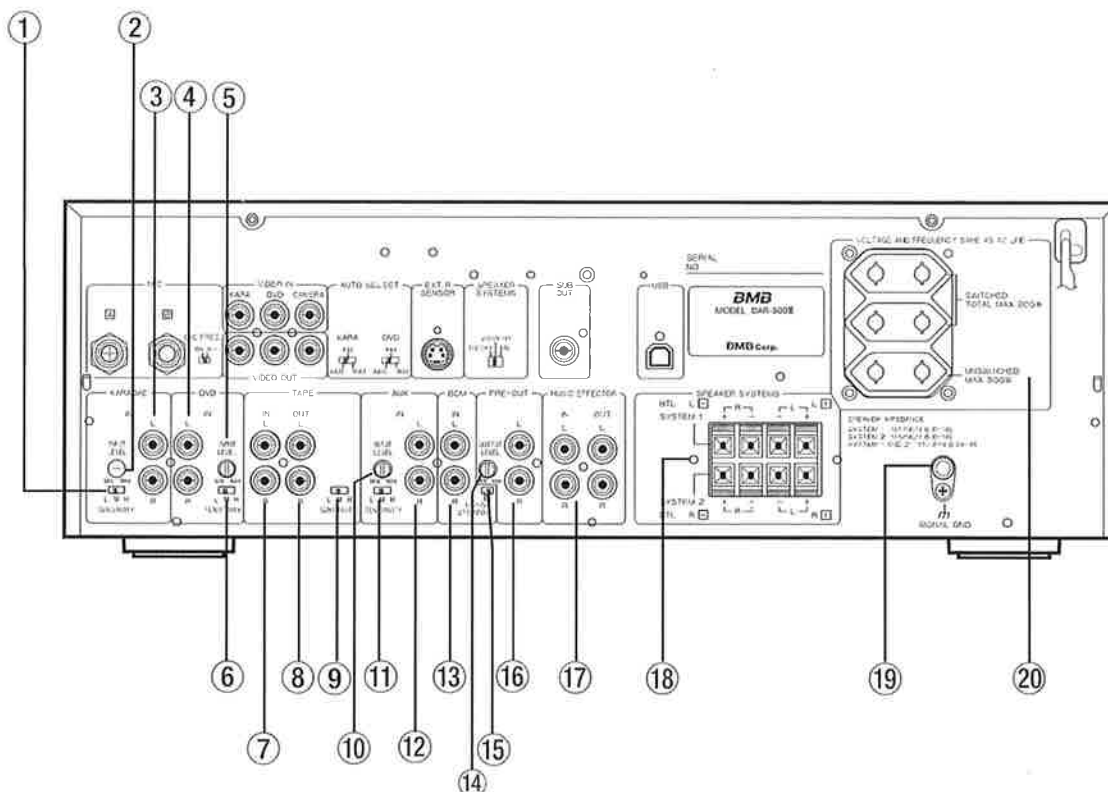

### ① KARAOKE SENSITIVITY switch

Set the sensitivity at which KARAOKE audio input level is detected and switched automatically.

L(ow): Set to this position when the function does not change to "BGM" or other mode even if KARAOKE play is over.

M(id): Set to this position in normal operating condition.

H(igh): Set to this position when the function changes to other mode during KARAOKE play.

### ② KARAOKE INPUT LEVEL control

Adjust this control by balancing with the level of other inputs (DVD, TAPE, AUX).

### ③ KARAOKE audio input jacks

Connect the audio output jacks of KARAOKE player here.

### ④ DVD audio input jacks

Connect the audio output jacks of DVD/CD karaoke player here (do not connect a BGV [background video] DVD player here).

### ⑤ DVD INPUT LEVEL control

Adjust this control by balancing with the level of other inputs (KARAOKE, TAPE, AUX).

### ⑥ DVD SENSITIVITY switch

Set the sensitivity at which DVD audio input level is detected and switched automatically.

L(ow): Set to this position when the function does not change to "BGM" or other mode even if DVD play is over.

M(id): Set to this position in normal operating condition.

H(igh): Set to this position when the function changes to other mode during DVD play.

### ⑦ TAPE audio input jacks

Connect the audio output jacks of tape deck here.

### ⑧ TAPE audio output jacks

Connect the LINE IN jacks of tape deck here. A level set by each input control other than the MIC MASTER VOL control and MUSIC VOL control is output here (this level has nothing to do with the speaker volume level).



### ⑨ TAPE SENSITIVITY switch

Set the sensitivity at which tape playback input level is detected and switched automatically.

L(ow): Set to this position when the function does not change to "BGM" or other mode even if tape play is over.

M(id): Set to this position in normal operating condition.

H(igh): Set to this position when the function changes to other mode during tape play.

#### Note:

If there is much noise between prerecorded tunes on the tape, the sensitivity may not be switched automatically even if this switch is set to L. Conversely, if the recording level is too low, the sensitivity may not be switched automatically even if this switch is set to H.

### ⑩ AUX INPUT LEVEL control

Adjust this control by balancing with the level of other inputs (KARAOKE, DVD, TAPE).

### ⑪ AUX SENSITIVITY switch

Set the sensitivity at which AUX audio input level is detected and switched automatically.

L(ow): Set to this position when the function does not change to "BGM" or other mode even if AUX source play is over.

M(id): Set to this position in normal operating condition.

H(igh): Set to this position when the function changes to other mode during AUX source play.

### ⑫ AUX audio input jacks

Connect the audio output jacks of external audio source equipment here.

### ⑬ BGM audio input jacks

Connect the audio source such as BGM (background music) from wired broadcasting system.

### ⑭ PRE-OUT output level control

Adjust this control by balancing with the level of power amplifier.

### ⑮ MONO/STEREO select switch

Select the required position according to the audio input from BGM (wired broadcasting system). If the BGM is a stereo source, connect L and R channels then set this switch to STEREO. If the BGM is a monaural source, connect either L or R channel, then set this switch to MONO.

### ⑯ PRE-OUT output jacks

Output terminals for use in connecting a power amplifier or mixer.

### ⑰ MUSIC EFFECTOR IN/OUT jacks

Input and output jacks for use in connecting an accessory unit such as a graphic equalizer.

#### Note:

Unless connection is proper, no sound will output.

### ⑱ SPEAKER SYSTEMS connectors

Connectors to which 6Ω to 16Ω speakers are connected. Please see page 12 for more information.

### ⑲ SIGNAL GND terminal

It is recommended to ground the unit in order to prevent this unit from electric shock or noise from other equipment. If grounding is provided, trouble with unknown cause may be remedied.

### ⑳ AC OUTLETS

- SWITCHED TOTAL MAX 200W  
Power is supplied to the connected equipment when the power switch of this unit is turned ON.
- UNSWITCHED MAX 300W  
Power is supplied to the connected equipment at all times irrespective of whether the power switch of this unit is ON or OFF.

#### Caution:

Never use the AC OUTLETS with their maximum ratings exceeded. **Do not connect a TV monitor as it draws a large current when power is switched ON.**

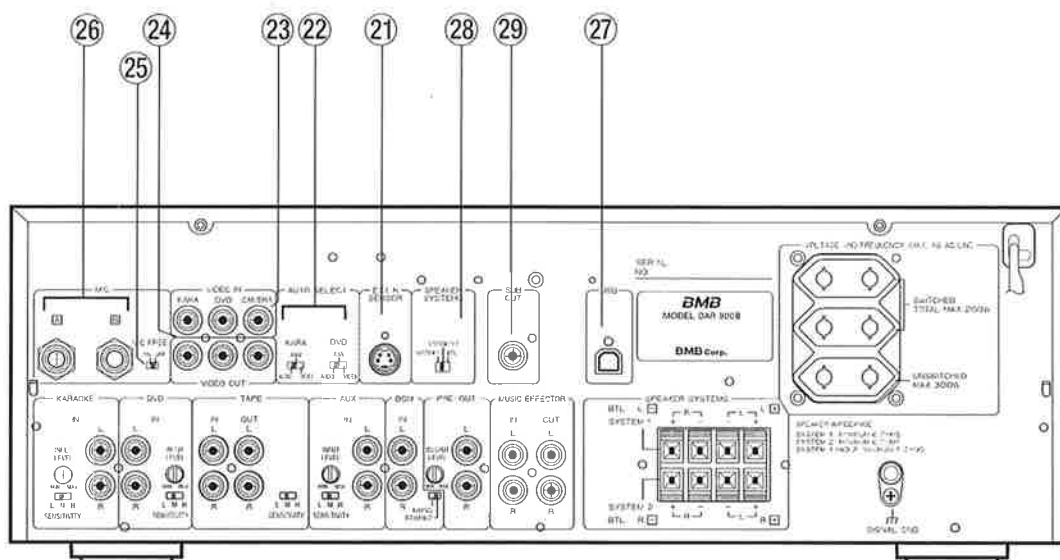

**21 EXT(ernal) REMOTE SENSOR terminal**

Terminal to which an external remote control unit is connected. If an external remote control unit is connected, the remote sensor (infrared signal reception window) on the front panel will be deactivated.

**22 AUTO SELECT switches**

Depending on the switch position, the detection mode will be switched from among the three modes, AUDIO, A & V or VIDEO (see page 17).

**23 VIDEO input jacks**

- KARAOKE: Connect the video output jack of karaoke unit here.
- DVD : Connect the video output jack of DVD karaoke unit here.
- CAMERA : Connect the video output jack of video camera here. The video signal input to this jack appears on the TV monitor when the function is set to BGM (wired broadcasting system), TAPE or AUX.

**24 VIDEO output jacks**

Up to three TV monitors can be connected to these video output jacks.

Note that the emcee microphone (3-MC) can be used at all times.

**25 MIC FREE switch**

Flipping this switch to ON allows the microphone to be used at all times. When the function is set to BGM (wired broadcasting system), this switch allows microphone sound to be turned ON or OFF. If this switch is set to OFF, no sound is output in the BGM mode.

**26 MIC [A][B] jacks**

Jack A is a mixing input jack with MIC INPUT 1 on the front panel whereas jack B is a mixing input jack with MIC INPUT 2.

**27 USB I/F (Interface)**

Connect USB cable for maintenance purpose. Not for normal use.

**28 BTL Selector switch**

BTL: Both speakers are driven by BTL AMP.

- SYSTEM 1 = L-Channel  L /  L
- SYSTEM 2 = R-Channel  R /  R

SYSTEM1+2:

- Each speaker system is driven individually (4 separate amplifiers).
- SYSTEM 1 = L-R (Stereo)
- SYSTEM 2 = L-R (Stereo)

SYSTEM1:

One pair of speaker is available (factory preset).

Please see page 12 for detailed example of speaker terminal setting.

**29 SUB OUT**

Connect the jack of the amplifier of Sub woofer for driving super low frequency (super low frequency = under 50Hz).

# SYSTEM CONNECTIONS

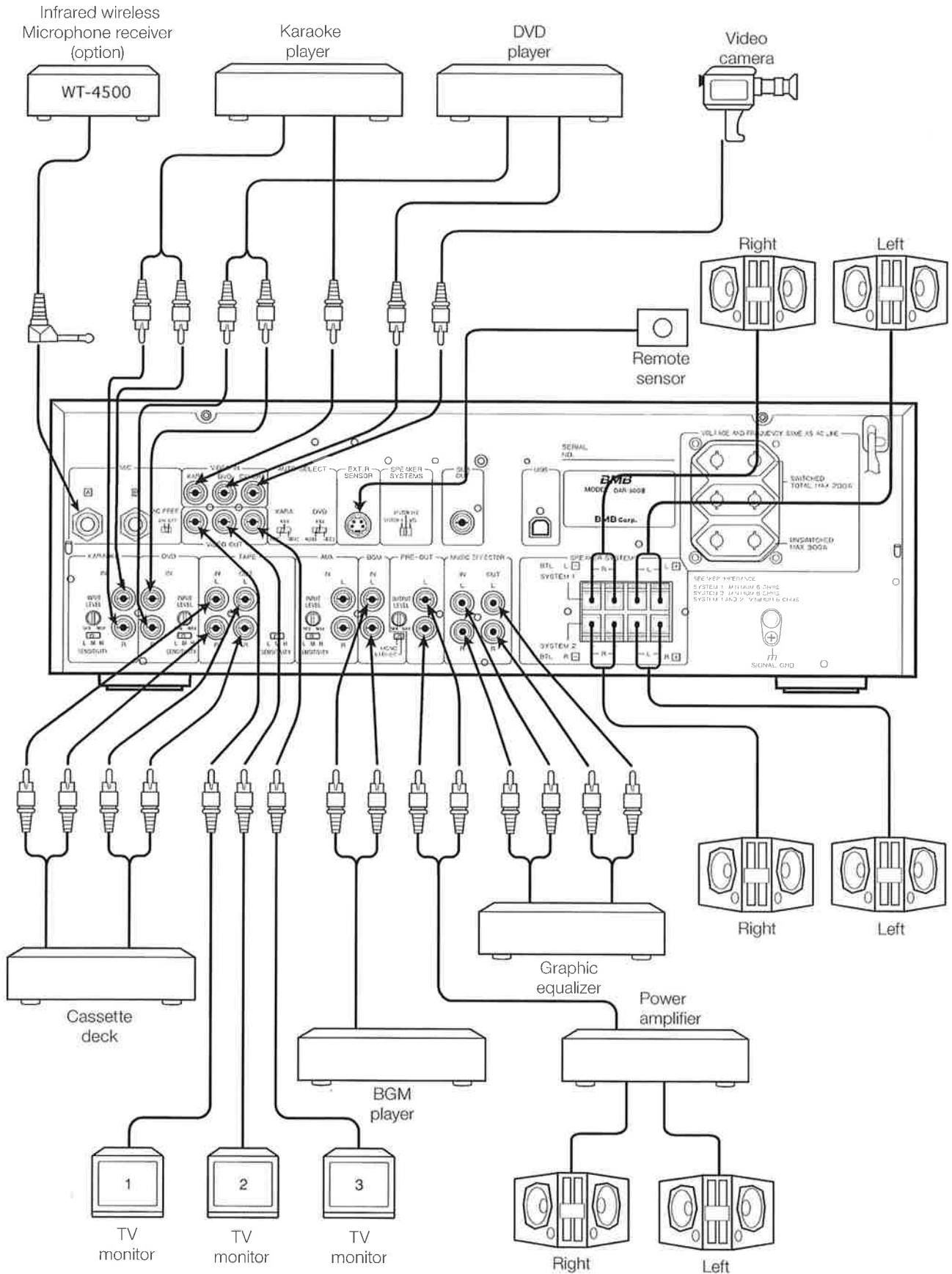

# CONNECTIONS

## How to connect speaker cords

1. Press the lever, then insert the stripped end of the cord.
2. Release the lever so that the wire is held securely.

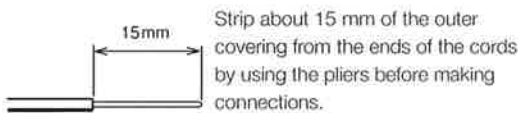
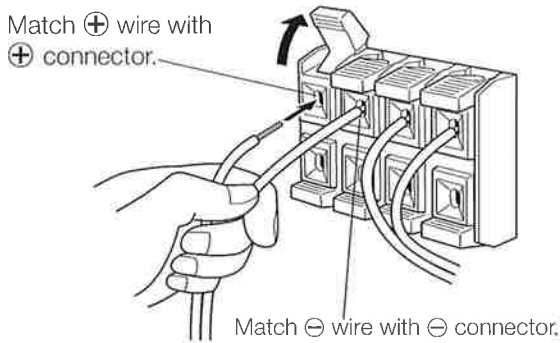

- When connecting RCA pin plug cords, match the colors. Connect red cord to red jack and white to white.

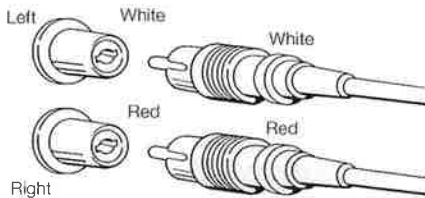

### Cautions:

- See that wire frays (straggly conductors) are not sticking out of the speaker connectors. If the wire frays come into contact with other conductors, it may lead to failure of the unit.
- Use speakers with a nominal impedance of 6Ω to 16Ω.
- If speakers with an impedance lower than 6Ω are connected, the protective circuit may go into operation, defeating normal stereo playback.
- When BTL setting is on, use speakers with a nominal impedance of 8Ω or more.

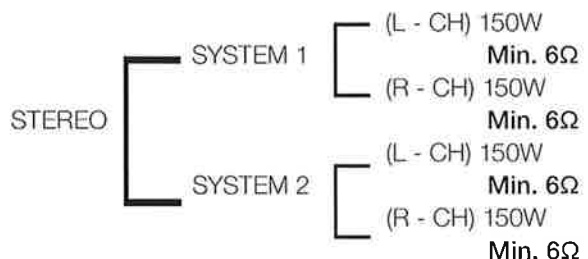
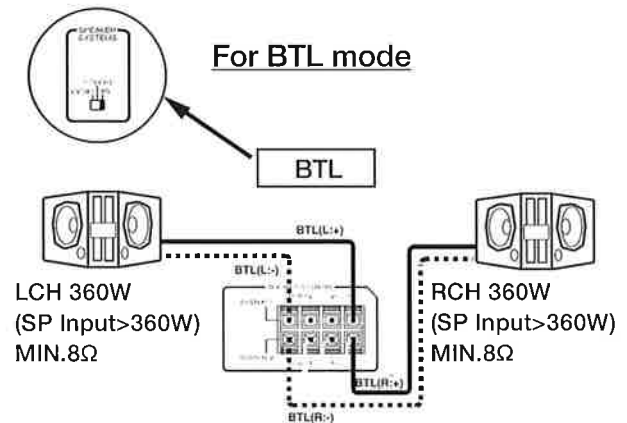
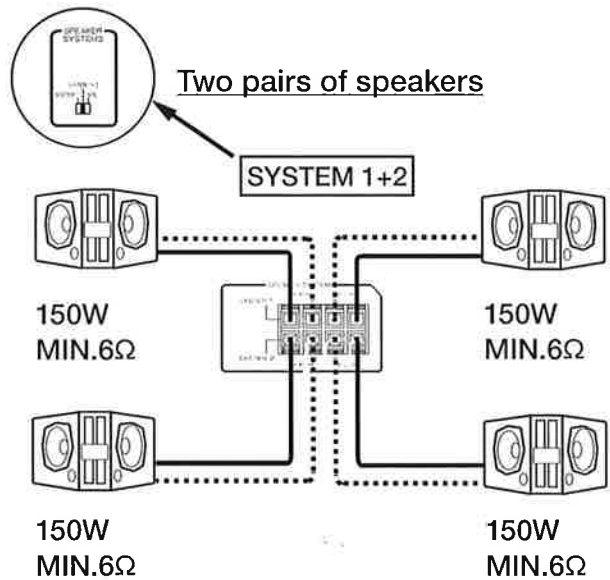
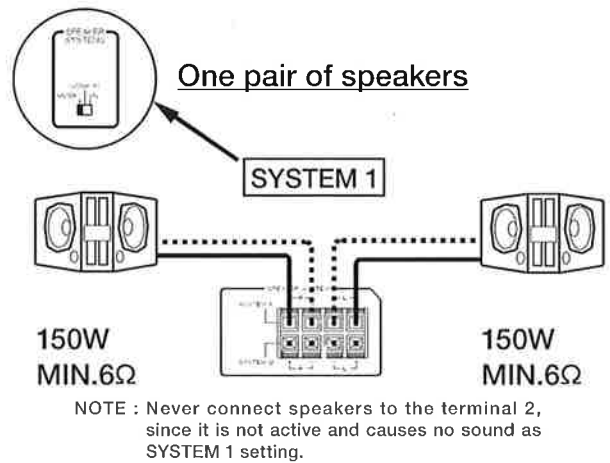

# MECHANISM TO PREVENT EXCESSIVE VOLUME LEVELS OF MIC MASTER VOL CONTROL AND MUSIC VOL CONTROL

Although usually the volume level can be varied from level 0 to a maximum level of 10, this feature allows you to change the maximum volume level to the required setting (such as up to 7, 8, 9, etc.).

## ■ Setting procedure

1. Remove the volume knob.
2. Remove the screw behind the knob, then reinstall it to the required maximum level.

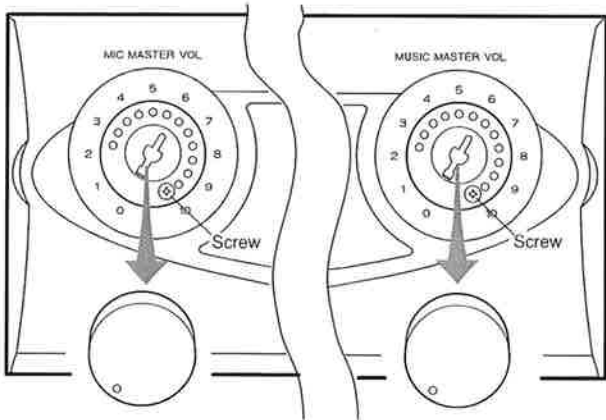

The MIC MASTER VOL control knob and MUSIC VOL control knob cannot turn more than the position where the screw is fixed.

Please set the maximum volume level to prevent over levelled driven and to protect speakers.

## CAUTION:

Please connect higher power handling speakers when you use this amplifier DAR-800II.

The maximum power of DAR-800II is over 360W/CH peak.

Please adjust each volume to obtain proper sound level by confirming the Input peak indicator and the Peak level indicators to prevent over load level and distortion. It should be avoided handling the highest power and over distortion since it would cause the trouble of the system. Never listen the sound near the speakers because the high sound pressure level will lead to ear problems.

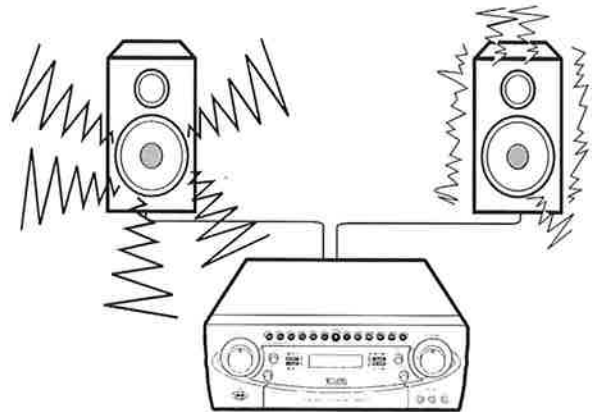

## DOOR LOCKING

The front door is available to lock from door opening for holding each setting adjust.

To release the door lock, slide the lock lever on the bottom of the front panel.



Push near the marking of door to open/close.

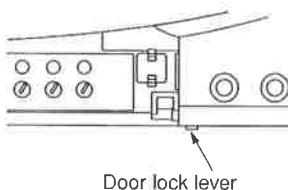

From the bottom view :

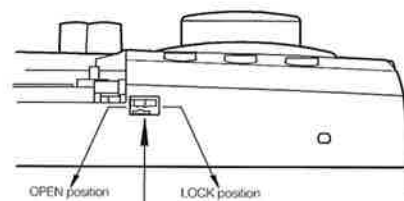

Slide the lever for door open/close

OPEN position : It is possible to open the front door by pushing right side of the door.

LOCK position : The front door is locked and unable to open the door. Lock the door for preventing tinker around setting.

## CAUTION :

Never close the door when the door stopper is on LOCK position, as it would cause the door broken.

# BASIC OPERATION

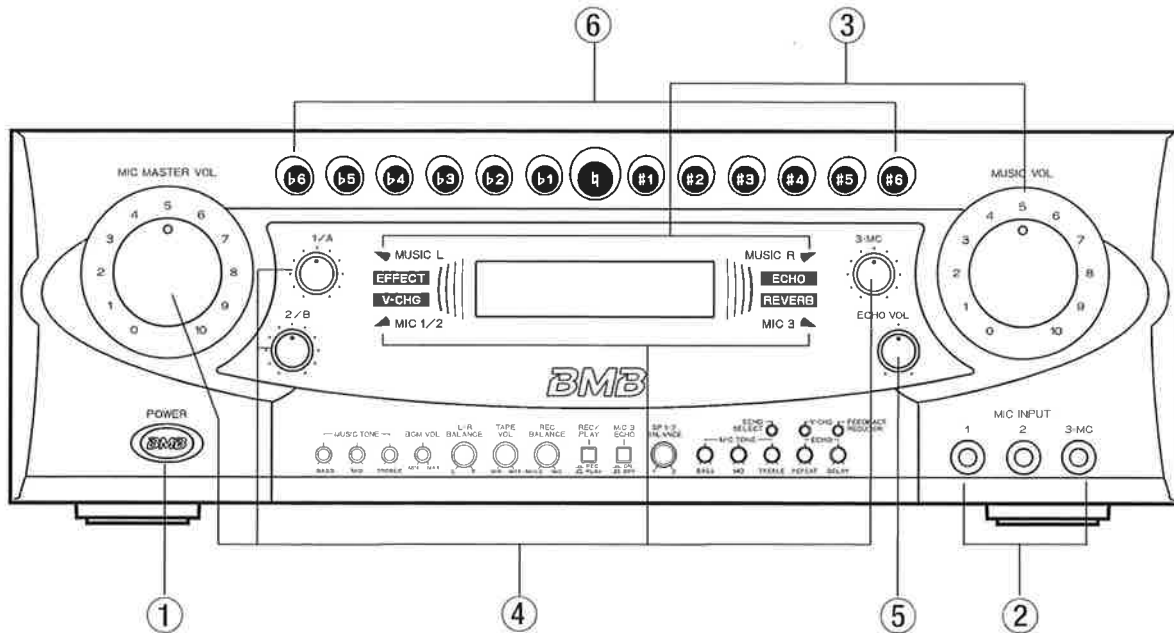

- ① Depress the power switch (⏻) of this unit and other equipment.
- ② Connect the required number of microphones.
- ③ Set the karaoke music machine to the play mode, then set the MUSIC VOL control to the required level, by checking the Peak level indicator of music input level.
- ④ Turn the MIC VOL controls and MIC MASTER VOL control to balance the level with that of music source, by checking the Peak level indicator of mic input level (MIC 1/A, 2/B, 3-MC).

**Notes:** ③ and ④

If the peak level indicator blinks with red, input level is too high, then reduce the input level by adjusting MUSIC VOL, or MIC MASTER VOL controls.

- ⑤ Adjust the echo level as required.
- ⑥ Adjust the pitch using the key control buttons.

Now that the required setting is over, you do not have to operate this unit. All you need to do is to operate the music source equipment.

## ■ How to use microphones properly and operating precautions

- Keep the microphone approx. 5 to 10 cm away from your mouth.
- To make the voice sound clearly, leave the proper space between the microphone head and holding position on the microphone.
- Do not cover the lower wind screen of the microphone. As this may muffle the bass sound, defeating proper vocal reproduction. It may also cause howling.
- When you use the IR microphone system, do not cover or shade the IR radiation parts (black plastic window) of microphone at the bottom as the wireless signal is weakened.

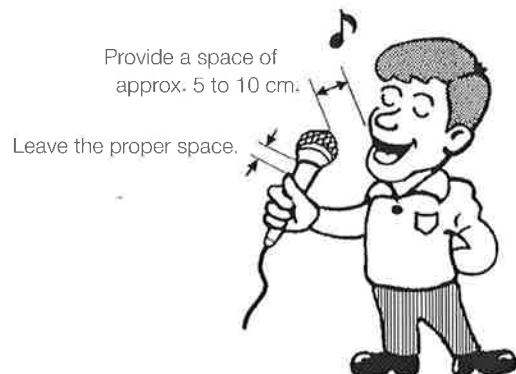

- Do not use the microphone toward the speaker as it may cause the feedback (howling).

# ECHO/EFFECT OPERATIONS

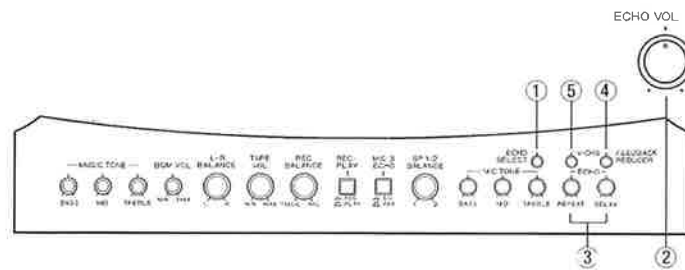

## Using Echo effectors

1. Select ECHO mode by pushing ① ECHO SELECT switch until ECHO Indicator is lit.
2. Adjust ECHO level of microphones to background music by ② ECHO VOL Control.
3. Adjust ECHO speed, and delay by turning ③ ECHO Controls.

### ① ECHO SELECT

Push this switch when selecting effectors including ECHO. The selected echo mode is indicated on LCD display, and it can change the following order;

ECHO → REV → MIX → ROCK →  
LED indicates "ECHO", "REVERB", "EFFECT".

## Effectors

| Name                 | LCD                                | FUNCTIONS  | PARAMETER | V-CHANGE |
|----------------------|------------------------------------|--|-----------|----------|
| ECHO                 | ECHO                               | ECHO Level, ECHO Rep, ECHO Delay   | 0~50      | X        |
| REVERB               | REVERB                             | REV REP, REVERB Level  | 0~50      | X        |
| MIX                  | MIX                                | Mix Echo and reverb  | 0~50      | X        |
| ROCK                 | ROCK                               | Rock sound effect level controllable   | 0~50      | ○        |
| ENKA                 | ENKA                               | Japanese Enka sound effect level controllable  | 0~50      | ○        |
| BALLAD               | BALLAD                             | Ballad sound effect level controllable   | 0~50      | ○        |
| FLANGER              | FLANGER                            | Flanger effect level controllable  | 0~50      | ○        |
| PANNING              | PANNING                            | Pans sound left and right  | 0~50      | ○        |
| DISTORTION           | DISTORTION                         | Distortion sound effect level controllable   | 0~50      | ○        |
| RADIO VOICE          | RADIO                              | Radio voice sound effect level controllable  | 0~50      | ○        |
| DUET                 | DUET                               | Duet sound effect level controllable   | -17~+17   | ○        |
| EFFECT OFF           | EFFECT OFF                         |  |           |          |
| VOICE CHANGE (V-CHG) | V-CHG OFF<br>V-CHG UP<br>V-CHG DWN | Voice change is not available<br>Voice change as hi-voice (1 octave up=Female voice)<br>Voice change lo-voice (1 octave down=Male voice) |           |          |
| FEEDBACK REDUCER     | FB-RED ON<br>FB-RED OFF            | Feedback reducer is activated.<br>Feedback reducer is stopped.   |           |          |

### ② ECHO VOL Control

For adjusting the entire echo and effect level of microphones 1/A, 2/B and 3/MC. Turn clockwise to increase it.

### ③ ECHO Controls (REPEAT/DELAY)

REPEAT: Adjust the echo sustaining duration.  
DELAY: Adjust the echo's repetition intervals.

### ④ FEEDBACK REDUCER

Push FEEDBACK REDUCER switch to prevent feedback (peaking of speakers feedback).  
LCD indicates as "FEEDBACK ON" when the effect is working (Please see ②7 on page 7 for CAUTION).

### ⑤ V-CHG selector switch

Vocal change function is available and V-CHG Indicator is lit when some effectors are selected.  
Please see the table above. "O" is available and "X" is not available.

V-CHG UP : Change the voice to high key's tone (like Female voice).

V-CHG DWN: Change the voice to low key tone (like Male voice).

# AUDIO/VIDEO SIGNAL DETECTION MODE

---

As for the KARAOKE and DVD functions, the detection mode will be switched from among the three modes (AUDIO, A & V or VIDEO) depending on the position of the AUTO SELECT switches on the rear panel. The AUX and TAPE functions should be detected by the audio signal.

- When the switch is set to "AUDIO"  
The audio input is detected, and the function will change in the following priority preset sequence:  
① KARAOKE, ② DVD, ③ AUX, ④ TAPE, and ⑤ BGM.  
For example, if there is no KARAOKE audio, and DVD and AUX are being played, priority will be given to the DVD audio, and DVD input is played.

- When the switch is set to "VIDEO"  
The video input is detected, and the function will change in the following sequence:  
① KARAOKE, ② DVD, and ③ Video camera.
- When the switch is set to "A & V"  
Either the audio input or video input is detected, and the function will change in the priority sequence.  
The audio will change in the following sequence:  
① KARAOKE, ② DVD, ③ AUX, ④ TAPE, and ⑤ BGM.  
The video will change in the following sequence:  
① KARAOKE, ② DVD, and ③ Video camera.  
If both audio and video are input, the function will be switched by the signal detected first.

## VIDEO SWITCHING

---

Although video signal is switched simultaneously with the switching of the audio signal, if the function is set to AUX, TAPE or BGM, the video signal input to the video camera will be output.

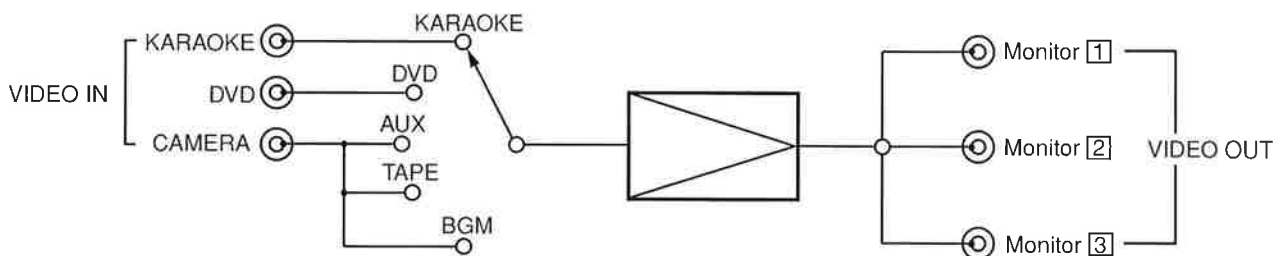



# REMOTE CONTROL OPERATION

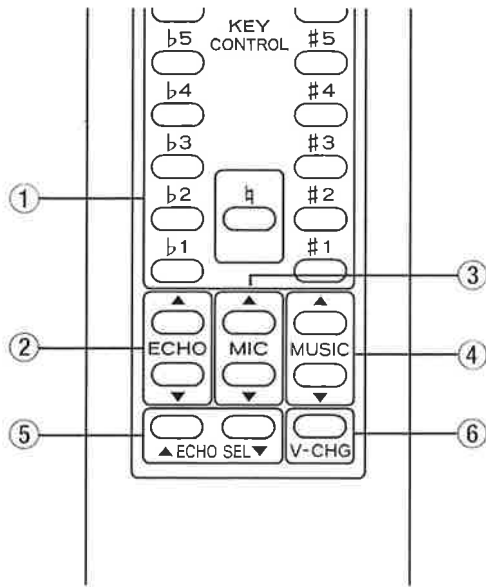

## ① KEY control buttons

- To increase pitch (#1 to #6) : This button can increase up to 3.0 pitches in six steps with a press of each button varying pitch in chromatic interval with respect to the standard pitch.
- Standard button (h) : Pressing this button allows the standard pitch to be resumed.
- To lower pitch (b1 to b6) : This button can decrease up to 3.0 pitches in six steps with a press of each button varying pitch in chromatic interval with respect to the standard pitch.

### Note :

When play of a tune is over, the standard pitch resumes automatically.

## ② ECHO control button

While holding down the button, the echo level will either increase or decrease depending on which side of the button is pressed.

## ③ MIC MASTER control button

While holding down the button, the volume level will either increase or decrease depending on which side of the button is pressed. At this time, the LED in the control knob on the front panel will flicker. Fine-adjustment of volume is possible by gently pressing the button.

## ④ MUSIC control button

While holding down the button, the volume level will either increase or decrease depending on which side of the button is pressed. At this time, the LED in the control knob on the front panel will flicker. Fine-adjustment of volume is possible by gently pressing the button.

## ⑤ ECHO SEL (select) button

While holding down the button, the programed effector is selected.

At this time, the selected effect is indicated to the LCD display.

Please see detailed information on page 15.

## ⑥ V-CHG select button

While holding down the button, the vocal change function is available.

At this time, "V-CHG" function is indicated to the LCD in the following order.

V-CHG OFF → V-CHG UP → V-CHG DOWN → V-CHG OFF →

Please see detailed information page 15.

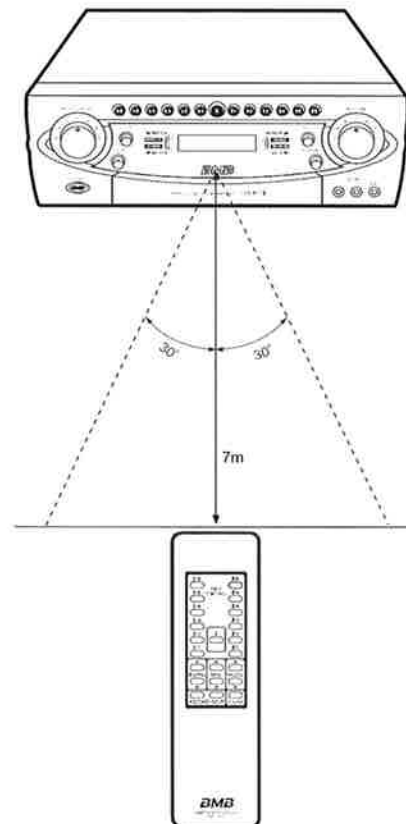

## ■ Wireless remote control

The allowable distance between the wireless remote control unit (RMR-800) and the remote sensor (infrared signal reception window) is approx. 7 m. Note that the remote control may not work if it is not properly pointed toward the remote sensor or if there is any obstacle between the remote control and the sensor.

# REMOTE CONTROL OPERATION

## Changing the batteries

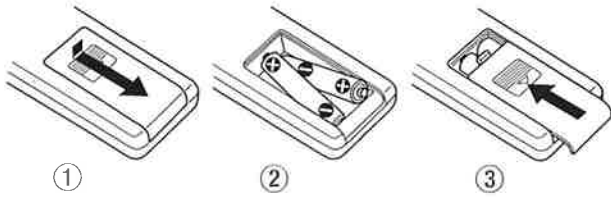

- ① Slide open the lid on the back side in the direction of the arrow.
- ② Insert two dry batteries (AAA,UM-4) as shown in above diagram.
- ③ Close the lid in the direction of the arrow.

### ATTENTION

The improper use of batteries may lead to chemical leakage or explosion.

Observe the following precautions:

- ① Insert batteries with their positive (+) and negative (-) poles positioned correctly according to the indication on the battery compartment.
- ② Do not use an old and new batteries together.
- ③ Use batteries of the same type. Never use batteries of different types together as voltage may be different, even if they are the same shape.
- ④ Discard exhausted batteries into a designated bin (so as not to contaminate the environment).
- ⑤ When you feel operating distance become shorter, the battery is exhausted. Replace with new batteries.

# TROUBLESHOOTING

| Trouble   | Possible cause  | Remedy   |
|---|---|--|
| No power is supplied to the unit.                           | <ul style="list-style-type: none"> <li>● The power plug is disconnected from the power outlet.</li> </ul>             | <ul style="list-style-type: none"> <li>● Firmly connect the power plug to the power outlet.</li> </ul>   |
| Power ON but no sound.                                      | <ul style="list-style-type: none"> <li>● Music Volume control or Mic Volume control may be set to minimum.</li> </ul> | <ul style="list-style-type: none"> <li>● Adjust for the proper sound level.</li> </ul>   |
|   | <ul style="list-style-type: none"> <li>● The speaker cables are disconnected.</li> </ul>                              | <ul style="list-style-type: none"> <li>● Connect the speaker cables properly.</li> </ul>   |
|   | <ul style="list-style-type: none"> <li>● Break in the speaker cables.</li> </ul>                                      | <ul style="list-style-type: none"> <li>● Repair the break in the cables.</li> </ul>  |
|   | <ul style="list-style-type: none"> <li>● Speaker cables are short - circuited.</li> </ul>                             | <ul style="list-style-type: none"> <li>● Repair the short - circuit.</li> </ul>  |
|   | <ul style="list-style-type: none"> <li>● Equipment to be connected are disconnected.</li> </ul>                       | <ul style="list-style-type: none"> <li>● Properly connect the equipment.</li> </ul>  |
| No sound at beginning of the music when switching function. | <ul style="list-style-type: none"> <li>● Sensitivity switch is set to "low".</li> </ul>                               | <ul style="list-style-type: none"> <li>● Set the Sensitivity switch to "high".</li> </ul>  |
|   | <ul style="list-style-type: none"> <li>● Output level of audio component is set to minimum.</li> </ul>                | <ul style="list-style-type: none"> <li>● Adjust it for suitable level if it has a level control.</li> </ul>  |
| No sound from microphone (but music is played back).        | <ul style="list-style-type: none"> <li>● Microphone switch is set to OFF.</li> </ul>                                  | <ul style="list-style-type: none"> <li>● Set it to ON.</li> </ul>  |
|   | <ul style="list-style-type: none"> <li>● Break in the microphone cord.</li> </ul>                                     | <ul style="list-style-type: none"> <li>● Repair or replace it.</li> </ul>  |
|   | <ul style="list-style-type: none"> <li>● The microphone plug is disconnected.</li> </ul>                              | <ul style="list-style-type: none"> <li>● Connect it properly.</li> </ul>   |
| No sound from microphone only when function is set to BGM.  | <ul style="list-style-type: none"> <li>● The MIC FREE switch is set to OFF.</li> </ul>                                | <ul style="list-style-type: none"> <li>● If it is set to OFF, no sound is output from microphones 1/2/A/B when the function is set to BGM.</li> </ul>  |
| No music sound (BGM and microphone sounds are available).   | <ul style="list-style-type: none"> <li>● No external unit with music effector jacks is connected.</li> </ul>          | <ul style="list-style-type: none"> <li>● Connect external unit to the MUSIC EFFECTOR jacks properly. If the unit connected to the IN jacks yet it is not connected to the OUT jacks, music sound is not output.</li> </ul> |

# TROUBLESHOOTING

| Trouble  | Possible cause   | Remedy   |
|--|--|--|
| No video.  | ● VIDEO OUT jacks are not fully connected.                       | ● Firmly insert TV monitor plug into VIDEO OUT jack.                             |
|  | ● VIDEO IN jacks (KARAOKE, DVD, CAMERA) are not fully connected. | ● Firmly insert plugs into VIDEO IN jacks.                                       |
| Function is switched to AUX, TAPE or BGM while playing KARAOKE or DVD.   | ● Input sensitivity of KARAOKE or DVD is low.                    | ● Set SENSITIVITY switch on the rear panel to H.                                 |
| No audio is played back even if KARAOKE or DVD audio signal is input.    | ● AUTO SELECT switches are set to VIDEO.                         | ● Set AUTO SELECT switches to AUDIO or A & V.                                    |
| Playback picture does not appear even if KARAOKE or DVD signal is input. | ● AUTO SELECT switches are set to AUDIO.                         | ● Set AUTO SELECT switches to VIDEO or A & V.                                    |
| No sound : Amplifier stops as error                                      | ● "ERROR 01" is indicated on LCD                                 | ● Power amplifier of SYSTEM-1 is error. Please see information as bellow.        |
| No sound : Amplifier stops as error                                      | ● "ERROR 02" is indicated on LCD                                 | ● Power amplifier of SYSTEM-2 is error. Please see information as bellow.        |
| No sound : Amplifier stops as error                                      | ● "ERROR 12" is indicated on LCD                                 | ● Power amplifier of SYSTEM-1 and -2 is error. Please see information as bellow. |

If an "ERROR" indication appears and no audio is output while using the unit, switch the power OFF, then check the following:

- ① Is the impedance of the connected speakers proper?  
See page 12 for more details.
- ② Isn't the amp temperature too high while using it?  
If it is, leave the unit for approx. 20 minutes, then use it with the volume lowered.

Check the left, then switch the power ON.  
At this time, see that the "ERROR" indication does not appear. If it still does, the unit is faulty; contact the dealer from whom you purchased it.

## MAINTENANCE

---

When the unit gets dirty, wipe with a soft dry cloth. If the unit is extremely dirty, soak a soft cloth in a diluted solution of dish-washing detergent (four - five parts of water to one part of detergent), wring the cloth, wipe the dirt away, then wipe the unit with a dry cloth. Never use alcohol, thinner, benzene, insecticide, or other

volatile agents, for they may damage the surface coating or deprive the luster from the unit. Also, do not wipe the unit with a chemical-impregnated cloth or leave it on the unit for a long period of time, for this may degrade the surface finish or strip off the coating.

## AFTER-SALE SERVICING

---

- ① If this unit is found to be defective, your local dealer will repair or replace defective parts with charge at your request.
- ② Before you request the repair to your local dealer, see the "TROUBLESHOOTING" section and check it again.

### For dealer :

If you are requested the after-sale service from your customer, check the following contents first.

- Confirming the details of the accident.
- Checking out all cables and connections.
- Caution of operation and instruction for using the system to your customer.

If the unit is found to be defective and it is difficult to repair, bring the defective unit to your nearest BMB authorized service center.

## MANNERS FOR CUSTOMERS

---

Karaoke, though enjoyable, could be noisy at times unless proper time and place are chosen. Please be sufficiently thoughtful of your neighbors.



Karaoke volume could be high if you are engrossed in singing.

Even a small sound can be penetrating especially at quiet night. Therefore, please give special attention to audio level especially at night. As no sound leaks to your neighbors, it is advisable to close the windows and observe proper manners to maintain pleasant living environment.

## COPYRIGHT

---

- Broadcasting, music source such as recorded music tape, DVD, video tape, CD and so on are strictly protected under copyright law.
- You need to have permission from the copyright holder to use, distribute, rent these music sources for commercial use, or sell dubbed media to other people except when enjoying these sources by yourself.

## ABOUT THE PRODUCT

---

- This unit is produced by harmless materials in conformity with relevant product safety laws.

# SPECIFICATIONS

## Amplifier

Audio output power:

150W + 150W + 150W + 150W (Separate 4 amps)  
360W + 360W (BTL)

Total harmonic distortion (1 kHz, -3 dB, 8Ω) .....0.1%

Audio input (sensitivity/impedance)

MIC .....6 mV/3.3 kΩ  
KARAOKE, DVD, TAPE, AUX.....300 mV/22 kΩ  
BGM (wired) .....300 mV/22 kΩ

Audio output (level/impedance)

PRE-OUT .....2.5 V/1 kΩ  
MUSIC EFFECTOR.....300 mV/1 kΩ  
Recording output .....300 mV/1 kΩ  
SUB OUT .....2.5 V/1 kΩ

Frequency response

MIC ..... 20 Hz to 20 kHz ±3 dB  
MUSIC .....10 Hz to 20 kHz ±3 dB

Tone control response

Music tone bass .....± 7 dB (100 Hz)  
Middle .....± 5 dB (2 kHz)  
Treble .....± 7 dB (10 kHz)  
Mic tone bass ..... ± 10 dB (100 Hz)  
Middle .....± 5 dB (2 kHz)  
Treble ..... ±10 dB (10 kHz)

Speaker impedance ..... 6Ω to 16Ω  
(one channel only, 1 or 2)

Key control range .....13 steps ± 3.0 pitch

Video input

(sensitivity/input impedance)..... 1 Vp-p/75Ω

Video output

(output level/output impedance) ..... 1 Vp-p/75Ω

## Power Supply / Others

<Singapore / Malaysia version>

Power supply ..... AC230V/50 Hz (Singapore)  
AC240V/50 Hz (Malaysia)

Power consumption ..... 840 W

AC outlet ..... SWITCHED x 2 (TOTAL MAX 200 W)  
UNSWITCHED x 1 (TOTAL MAX 300 W)

Dimensions (W x H x D)..... 420 x 142 x 396 mm

Weight.....17.1 kg

Accessories

Owner's manual ..... 1  
Wireless remote control unit (RMR-800)..... 1  
AAA (UM-4) batteries ..... 2

- Design and specifications subject to change without notice.

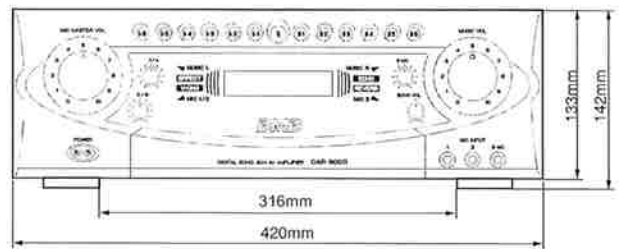
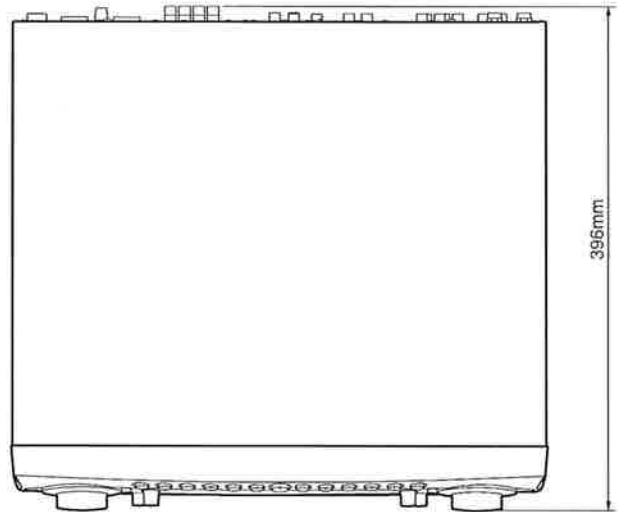

**BMB Corp.**  
<http://www.bmb.co.jp>

**BMB (Shanghai)  
International Corp.**  
<http://www.bmb.com.cn>